



**PART 1 (11)**

**10 000 KM SERVICE**

**(6 000 MILES)**

**CARS**

**SERVICE  
MANUAL**

## CONTENTS

Specifications .....	2
General .....	5
Description, Wheel-Alignment Indicator .....	6
Volvo-Tester .....	7
Description of Work, 10 000 km (6 000 miles) service	8
10 000 km (6 000 miles) service without Volvo-Tester .....	37

# FOREWORD

This manual deals with the Volvo 10 000 km (6 000 miles) service (with or without the Volvo-Tester) and the Volvo test. Points 1—25 of the instructions for servicing with a Volvo-Tester are to be followed when carrying out the 10 000 km (6 000 miles) service without the Volvo-Tester.

Points 26 u—34 u (see page 37) and points 35—85 of the instructions for servicing with a Volvo-Tester are thereafter to be followed.

In carrying out the Volvo test, only those points marked \*) in the instructions for the 10 000 km (6 000 miles) service are to be followed.

Concerning any repairs in connection with servicing, see the respective service manual.

# SPECIFICATIONS

## ENGINE

### Valve clearances

B 18 A .....	0.40—0.45 mm (0.016—0.018")
B 18 D (90 h.p.) .....	0.40—0.45 mm (0.016—0.018")
B 18 D (95 and 100 h.p.) .....	0.50—0.55 mm (0.020—0.022")
B 18 B .....	0.50—0.55 mm (0.020—0.022")
B 20 A .....	0.40—0.45 mm (0.016—0.018")
B 20 B .....	0.50—0.55 mm (0.020—0.022")
B 20 E .....	0.40 mm (0.016")
B 30 A .....	0.50—0.55 mm (0.020—0.022")

### Carburetors

#### ADJUSTING IDLING

B 18 A .....	500—700 r.p.m.
B 18 D .....	500—700 r.p.m.
B 18 B .....	600—800 r.p.m.
with exhaust emission control .....	800 r.p.m.
B 20 A .....	700 r.p.m.
B 20 B .....	800 r.p.m.
with automatic transmission .....	700 r.p.m.
B 30 A .....	800 r.p.m.
with automatic transmission .....	700 r.p.m.
B 20 E .....	900 r.p.m.

### Radiator test

B 18 .....	0.5 kp/cm <sup>2</sup> (7 p.s.i.)
B 20 and B 30 A .....	0.7 kp/cm <sup>2</sup> (10 p.s.i.)
No significant pressure drop within 30 seconds.	

### Tightening torques

Attaching bolts, fuel pump .....	1.8—2.2 kpm (13—16 lb.ft.)
Manifold nuts .....	1.8—2.2 kpm (13—16 lb.ft.)
Attaching bolts, engine mountings .....	1.8—2.2 kpm (13—16 lb.ft.)

## ELECTRICAL SYSTEM

### Battery

Electrolyte spec. weight:	
Fully-charged battery .....	1.28
Charging to take place at .....	1.21

### Alternator

Charging voltage .....	13.0—15.0 volts
(measured between B+ and B— on battery)	

**Ignition coil**

Start voltage .....	min. 20 KV
Max. available voltage .....	min. 25 KV

**Spark plugs**

Electrode gap .....	0.7—0.8 mm (0.028—0.032")
Tightening torques .....	0.5—4.0 kpm (25—29 lb.ft.)

**Distributor****DWELL ANGLE**

B 18, B 20 .....	59—65°
B 30 A .....	37—43°
Max. variation, at different speeds and with vacuum governor switched on and off, 2°.	

**Ignition setting****BASIC FIRING POSITION**

B 18 A, B 20 A .....	21—23° B.T.D.C. at 1 500 r.p.m. (vacuum governor disconnected)
B 18 D (90 h.p.) .....	22—24° B.T.D.C. at 1 500 r.p.m. (vacuum governor disconnected, if fitted)
B 18 D (95—100 h.p.) .....	17—19° B.T.D.C. at 1 500 r.p.m. (vacuum governor disconnected, if fitted)
B 18 B .....	17—19° B.T.D.C. at 1 500 r.p.m.
B 18 B with exhaust emission control .....	3—5° B.T.D.C. at max. 850 r.p.m.
B 20 B .....	10° B.T.D.C. at 600—800 r.p.m. (vacuum governor disconnected, if fitted)
B 30 A .....	10° B.T.D.C. at 600—800 r.p.m. (vacuum governor disconnected)
B 20 E .....	10° B.T.D.C. at 700—800 r.p.m. (vacuum governor disconnected)

**AT 2 500 r.p.m., DISCONNECTED VACUUM GOVERNOR**

B 18 A and D .....	31—35° B.T.D.C.
B 18 B .....	31—35° B.T.D.C.
B 18 B with exhaust emission control .....	26—30° B.T.D.C.
B 20 A .....	31—35° B.T.D.C.
B 20 B .....	25—29° B.T.D.C.
B 30 A .....	27—31° B.T.D.C.
B 20 E .....	27—31° B.T.D.C.

**AT 2 500 r.p.m., CONNECTED VACUUM GOVERNOR  
(POSITIVE CONTROL)**

B 18 A and D, B 20 A, B 30 A .....	Check that firing position is raised considerably, when vacuum governor is connected.
------------------------------------	---

**AT 600—800 r.p.m., CONNECTED VACUUM GOVERNOR  
(NEGATIVE CONTROL)**

B 20 B .....	3—5° B.T.D.C.
B 30 A .....	3—5° B.T.D.C.
B 20 E (700—800 r.p.m.) .....	2° B.T.D.C. —2° E.T.D.C.

**CLUTCH**

Clutch fork play .....	3—4 mm (0.12—0.16")
------------------------	---------------------

**FRONT END**

**Wheel angles (unloaded vehicle)**

Caster .....	0 to +1°
(Difference between both wheels must not exceed 0.5°)	
Camber .....	0 to +0.5°
Steering knuckle inclination at 0° camber .....	7.5° (120-series 8°)
Toe-in .....	0—4 mm (0—0.16")
Curve angles	
At 20° turning of outer wheel, inner wheel should be turned 21.5—23.5°.	

## GENERAL

The 10 000 km (6 000 miles) service is carried out in a special work bay fitted with such instruments

and tools as: Lift, wheel-alignment indicator, Volvo-Tester and wheel balancer.

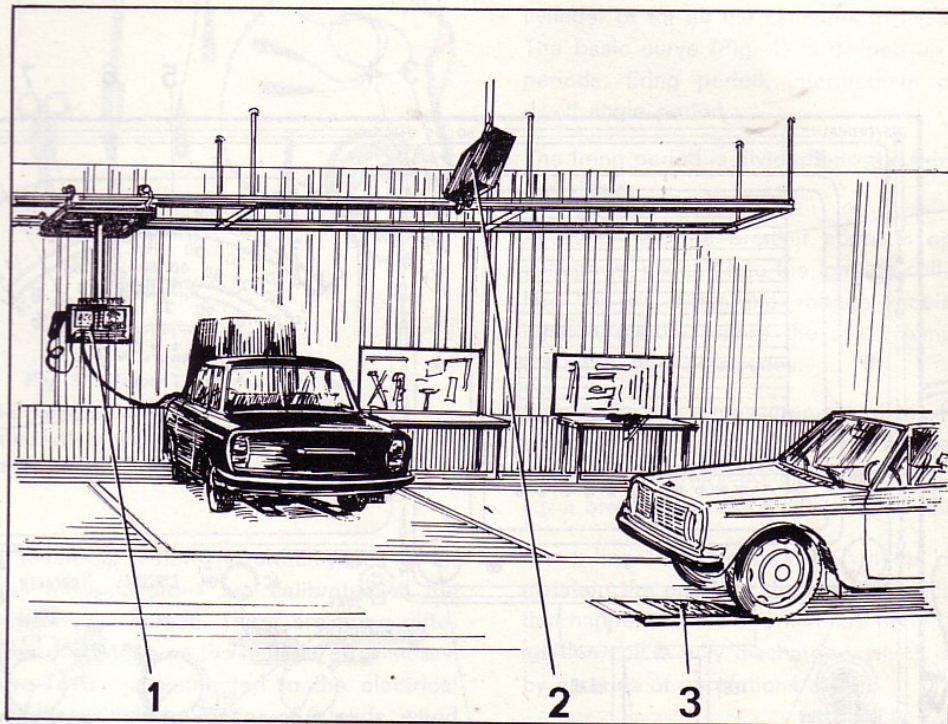

VOLVO  
104701

Fig. 1. Inspection bay

1. Volvo-Tester
2. Registering panel for wheel-alignment indicator
3. Wheel-alignment indicator

# DESCRIPTION

## WHEEL-ALIGNMENT INDICATOR

This unit consists of the actual wheel-alignment indicator, which is installed in the floor, and a registering panel, which can be mounted in a suitable place.

The registering panel has two red and one green lamps as well as a switch. Inside there is a buzzer, which starts buzzing when one of the red lamp lights.

When the switch is on, the green lamp lights, this indicating that the wheel-alignment indicator is ready for use. If any of the red lamps lights, this means that the wheel-alignment indicator is not set to zero. Normally, zero-setting is carried out when the vehicle wheel rolls over the tread plate

and depresses the pedal at the end of the plate. The indicator can also be zero-set manually by tramping on the pedal. If the front end of the car is as it should be, the wheels roll parallel and the movable part of the plate will not be displaced. Under such circumstances, the green lamp remains lighted.

If the front end is incorrectly adjusted, the front wheels will not roll parallel but will displace the movable section of the tread plate. This causes electrical impulses to be transmitted to the registering panel, where one of the red lamps lights and the buzzer emits a buzzing sound. This means that the front wheel adjustment should be checked with the proper instruments and put right.

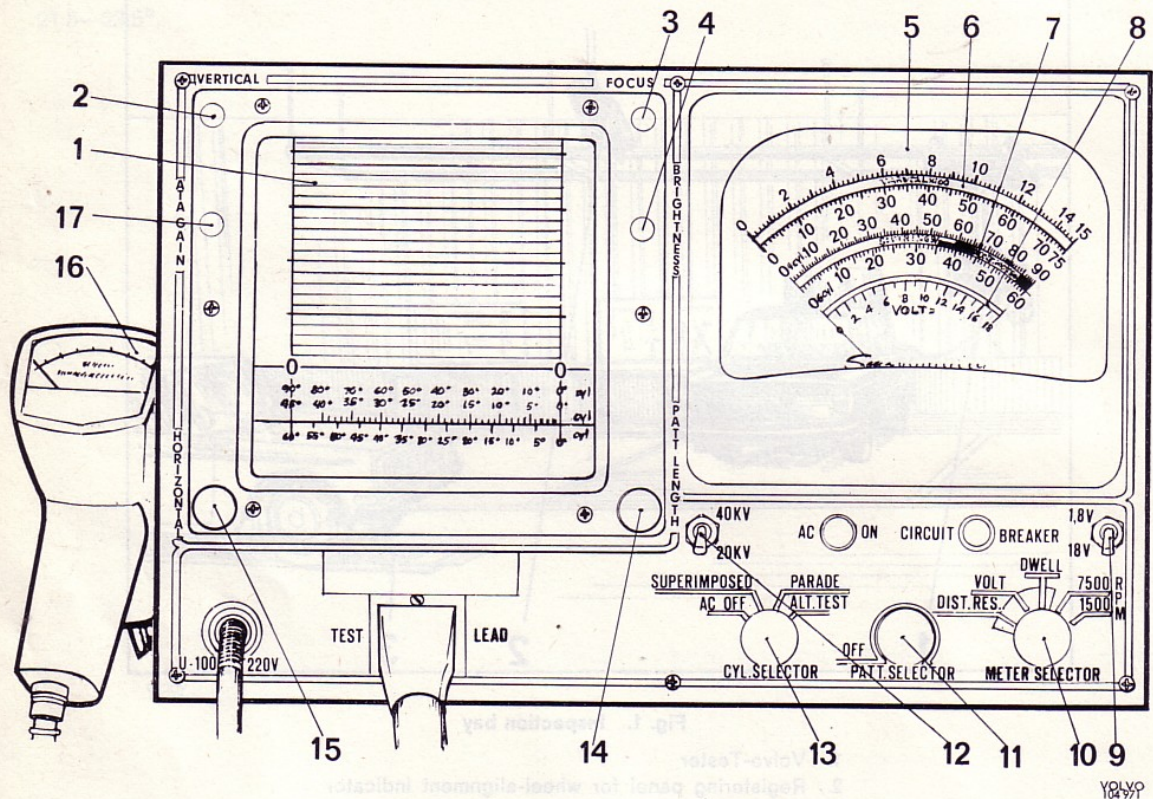

Fig. 2. Volvo-Tester

- |  |   |
|--|---|
| 1. Screen                                    | 10. Meter selector                                    |
| 2. Vertical control (raises or lowers curve) | 11. Cylinder selector                                 |
| 3. Focus control                             | 12. 20-40 KV switch                                   |
| 4. Brightness control                        | 13. Pattern selector                                  |
| 5. Meter                                     | 14. Pattern length                                    |
| 6. R.p.m. scale                              | 15. Horizontal control (moves curve to left or right) |
| 7. Dwell angle scale                         | 16. Ignition setting lamp                             |
| 8. Voltage scale                             | 17. ATA gain  |
| 9. 1.8-18 V scale switch                     |   |

## VOLVO-TESTER

The Volvo-Tester consists of an oscilloscope and a combined voltage — dwell angle — speed meter, see Fig. 2.

The oscilloscope makes it possible to check graphically ignition voltage, the function of the ignition coil and distributor breaker contacts, also the isolation in the high-tension circuit. With it, it is also possible to check the rectifier diodes in the alternator.

The oscilloscope screen is graduated in KV (1 kilo-volt, KV=1000 volts). To the left of the screen, the graduation is 0—20 KV, on the right, it is 0—40 KV. Switching between the different ranges is

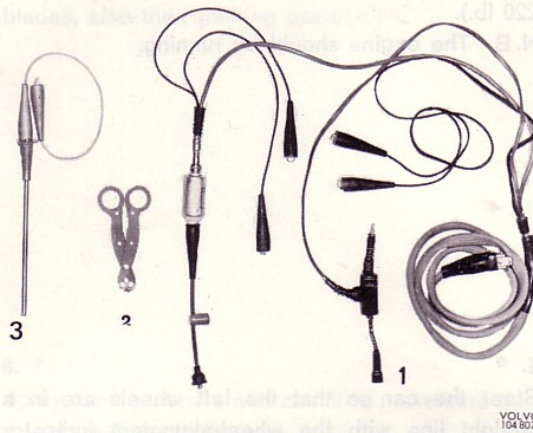

Fig. 3. Volvo-Tester accessories

1. Cable harness
2. Isolated pliers, for ignition leads
3. Ground probe

done by means of a flip-type switch (12, Fig. 2). The dwell angle degrees are calibrated at the lower edge of the screen. There are three different scales depending on the number of cylinders. The Volvo-Tester is connected to the electrical system of the vehicle by means of 6 leads, wired in a cable harness (Fig. 3), which is connected to the Volvo-Tester via a plug.

### BASIC CURVE

The entire firing cycle can be read off on the oscilloscope screen, either for each individual

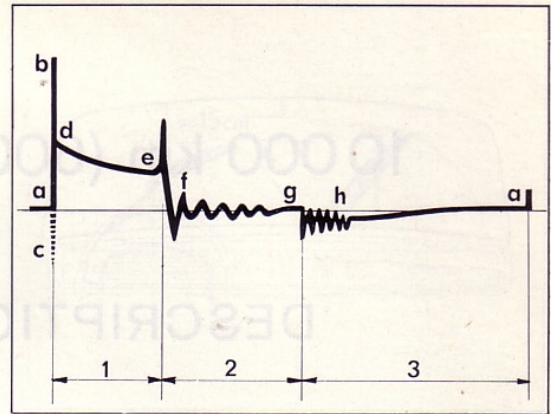

Fig. 4. Basic curve

1. Firing period
2. Intermediate period
3. Dwell angle period

cylinder or for all the cylinders at the same time. The basic curve (Fig. 4) is divided up into three periods: firing period, intermediate period and dwell angle period.

The firing period is divided into the firing line and spark line.

At point "a", the breaker contacts open and a voltage is induced into the ignition coil. The firing line "a—b" shows the voltage required in the ignition system before the spark jumps over to the spark plug electrodes.

Line "a—c" is a measurement of the isolation in the high-tension section. A reading is obtained when a spark plug lead is disconnected, thus causing a breakage in the high-tension circuit.

Spark line "d—e" shows the voltage required to maintain the spark at the moment of ignition. All that happens in the intermediate period is that the ignition coil is fully discharged, which is indicated by a series of oscillations at "f".

Just prior to the dwell angle period, the breaker contacts close. This is indicated by a short descending line at "g" and small diminishing oscillations at "h".

The basic curve shows the cycle for No. 1 cylinder, but all the cylinders can be read off on the screen in their firing order.

# 10 000 km (6000 miles) service

## DESCRIPTION OF WORK

VOLVO  
104 704

### 1. \*

When driving in the car, depress the brake pedal with maximum possible force (at least 100 kp= 220 lb.).

N. B. The engine should be running.

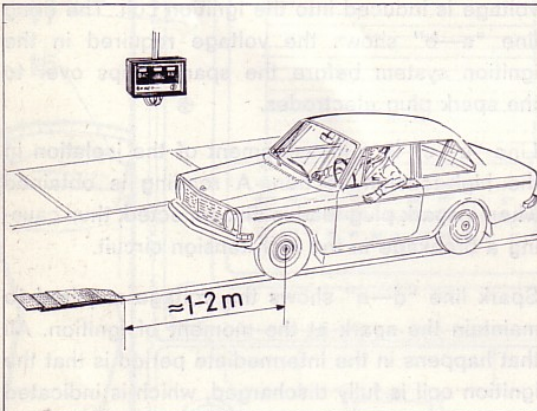
VOLVO  
104 705

### 2. \*

Steer the car so that the left wheels are in a straight line with the wheel-alignment indicator when the car is about 2 m (6 1/2 ft.) from the indicator. **Release** the steering wheel and let the car roll slowly up over the aligner (2—4 km.p.h.= 2 m.p.h.). N. B. The steering wheel **must not** be touched until the front wheels have passed over the aligner.

If the green lamp remains lighted on the registering panel, then the front wheels are properly adjusted and the wheels run parallel.

If one of the red lamps lights, and the buzzer emits a buzzing sound at the same time, the front wheel alignment is at fault and should be adjusted.

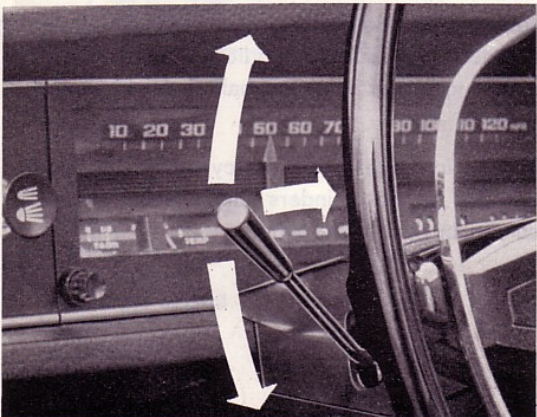
VOLVO  
104 706

### 3. \*

Check to make sure that the following are functioning satisfactorily: parking lights, fullbeam and dipped, control lamps, fullbeam flashers, instrument lighting, glove locker lighting, interior lighting incl. door switches, rear lights, back-up lights, turn indicators, stop lights, license plate lighting and the inside rearview mirror.

## 4. \*

Check the function and setting of the windscreen washers. (The water jets from the nozzles should strike the windscreen about 15 cm = 1/2" from the top edge).

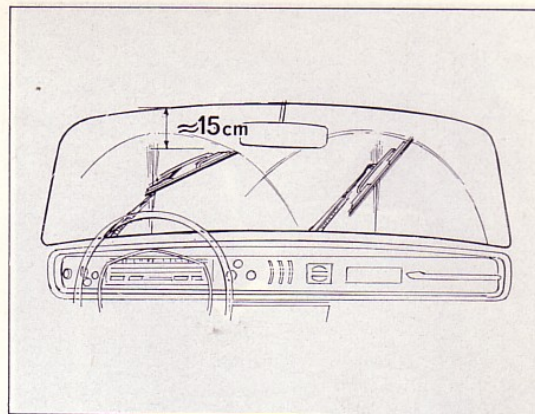
VOLVO  
104707

## 5. \*

Check the function of the windscreen wiper. (Full and half speed, effectiveness and condition of blades, also their parking position.)

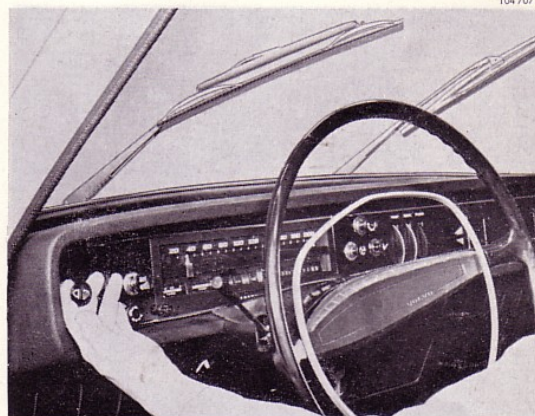
VOLVO  
104708

## 6. \*

Apply the handbrake and check to make sure that it locks satisfactorily. Check that the handbrake is not applied beyond the 3rd or 4th ratchet notch. Switch on the ignition and check that the brake warning lamp lights when the parking brake is applied.

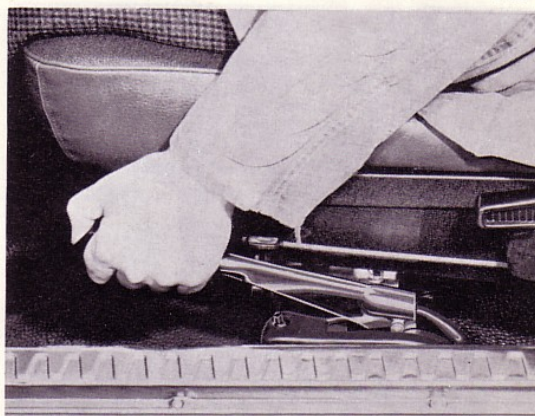
VOLVO  
104709

## 7. \*

Check for any play in the front end (steering gear) with small turns of the steering wheel.

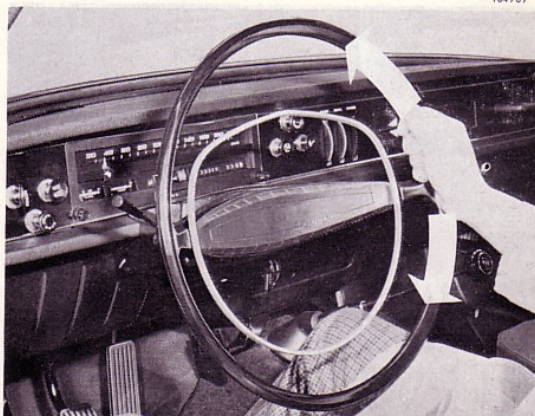
VOLVO  
104710

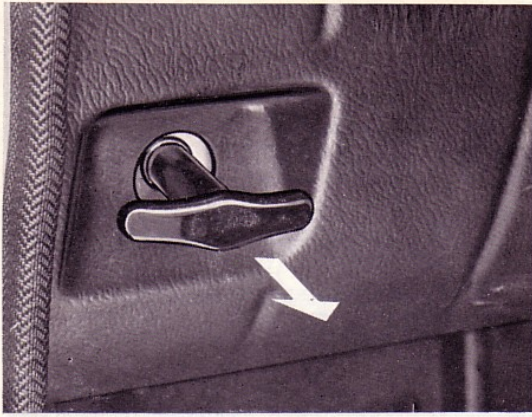

VOLVO  
104711

**8. \***

Check the horn.  
Open the hood (bonnet).



VOLVO  
104712

**9. \***

Check the straps of the safety belts, also locks and attachments.

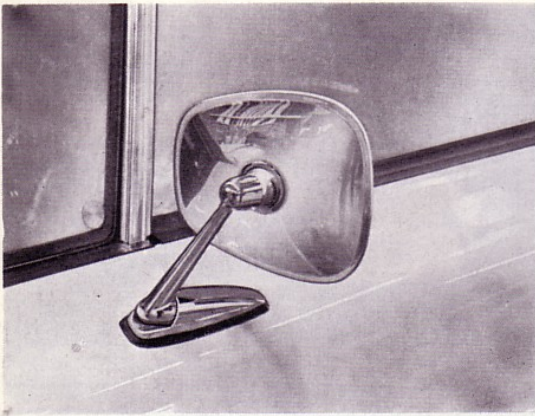

VOLVO  
104713

**10. \***

Check the glass and mounting of the outside rear-view mirrors.  
Check all lamp glass and any reflectors.

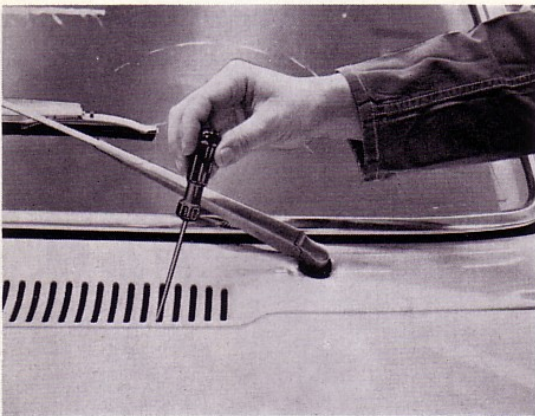

VOLVO  
104713

**11.**

If necessary, adjust the windscreen washer nozzles.

**12. \***

Open the hood (bonnet).  
Place a protective cover over the front mudguards.

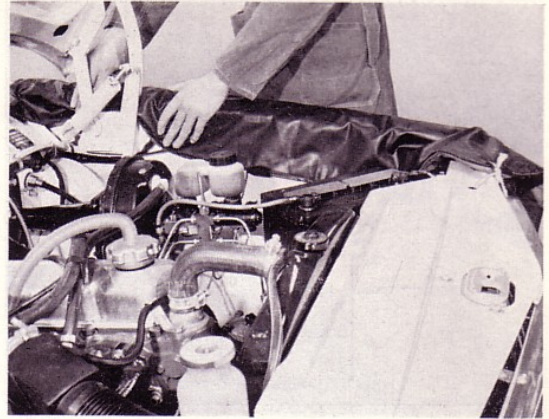
VOLVO  
104714**13. \***

Fit the radiator tester.  
Carefully pump up the pressure.  
For B 18: 0.5 kp/cm<sup>2</sup> (7 p.s.i.).  
B 20, B 30: 0.7 kp/cm<sup>2</sup> (10 p.s.i.).

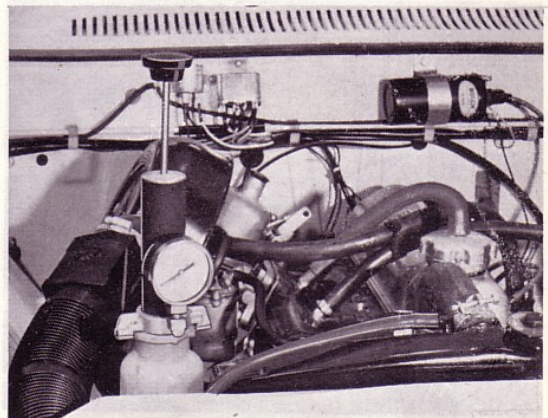
VOLVO  
104715**14. \***

Check the acid level of the battery.  
If necessary, fill with **distilled** water to about 5 mm (3/16") above the plates in the battery.  
Clean and lubricate the battery pole shoes with rustproof oil (Tectyl, Dinitrol, etc.).  
Check to make sure that the pole shoes and battery are fitted securely. (No cleaning or lubricating during the Volvo test).

VOLVO  
104716**15. \***

Read off the radiator tester. The pressure must not drop noticeably. Check and, if necessary, fix any leakage. Remove the radiator tester. Fill with a 50-50 mixture of glycol and water if necessary. (No filling during Volvo test).

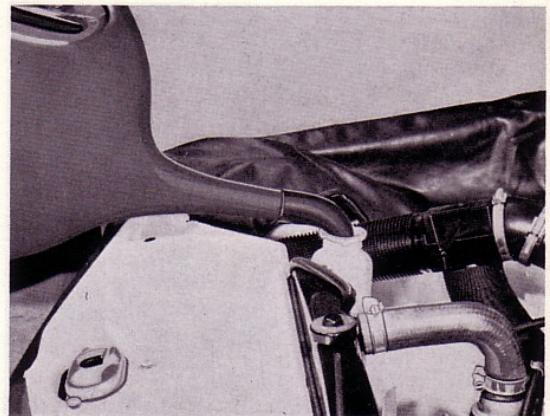
VOLVO  
104717

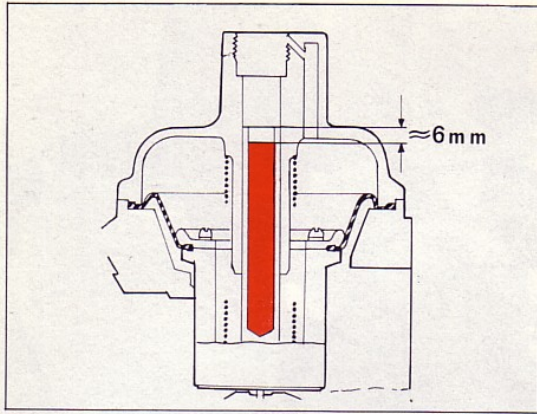

Y04822

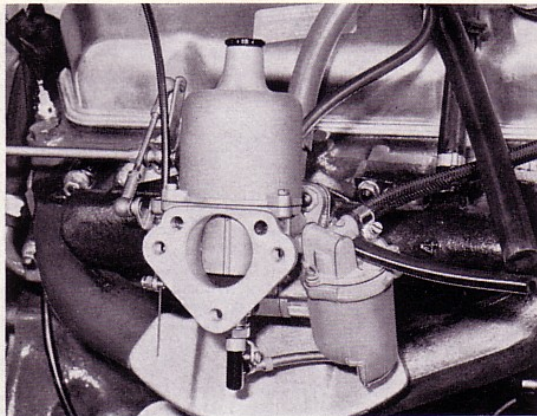
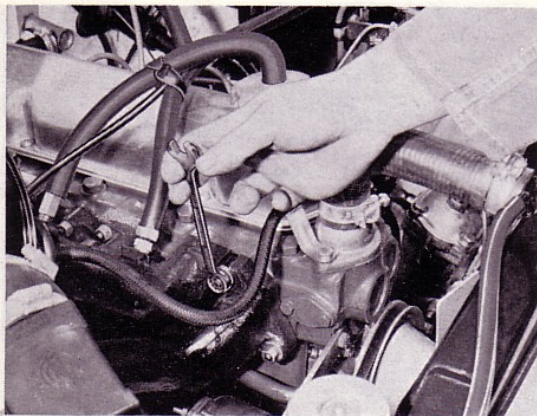
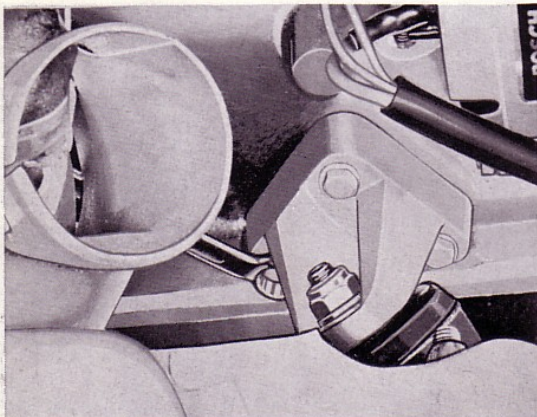
VOLVO  
104819VOLVO  
104713

Y04818

**16.**

Check the throttle control and shutter spindles. Lubricate ball joints and shutter spindles with oil. Check and, if necessary, fill the carburettor(s), damping cylinder(s), with oil. The spindle in the piston should be filled to about 6 mm (1/4") from the upper edge with automatic transmission fluid. Check to make sure there is no fuel leakage at the carburettor(s).

**17.**

Change the air cleaner at the 40 000 km (24 000 miles) service.

**18.**

Check-tighten the manifold nuts.  
(Tightening torque: 1.8—2.2 kpm = 13—16 lb.ft.).

**19.**

Check-tighten the bolts securing right engine mountings to cylinder block.  
(Tightening torque: 1.8—2.2 kpm = 13—16 lb.ft.).

**20.**

Check the fluid level in the windscreen washer container. Fill with clean water if necessary. (If necessary, add cleansing and anti-freeze fluid.)

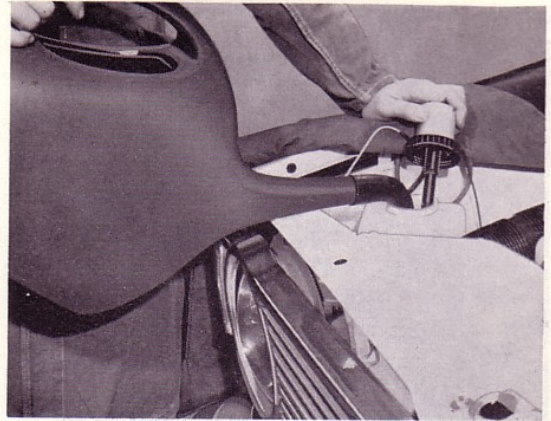
VOLVO  
104719**21.**

Check-tighten the mounting bolts for the fuel pump. (Tightening torque: 1.8—2.2 kpm = 13—16 lb.ft.). Clean the sludge collector in the fuel pump. Check the gasket of the cap and replace if necessary.

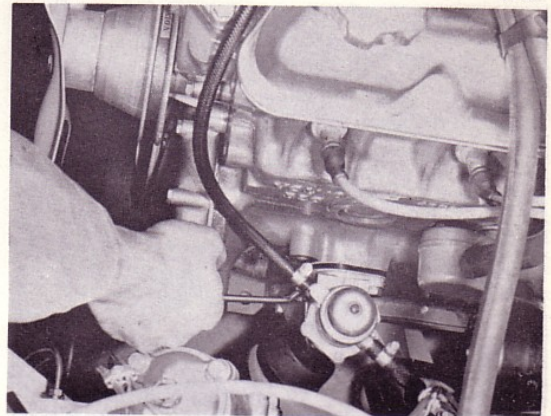
VOLVO  
104720**22.**

Check the bolts securing the left engine mountings to the cylinder block. (Tightening torque: 1.8—2.2 kpm = 13—16 lb.ft.)

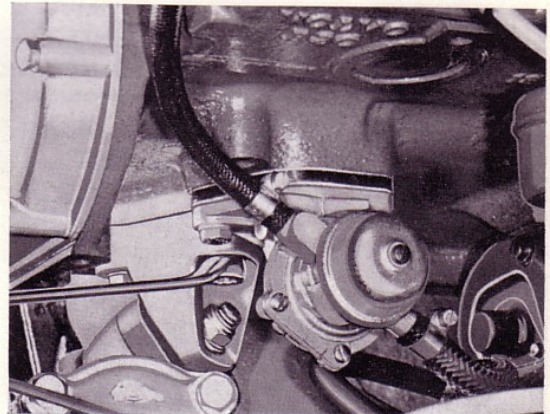
VOLVO  
104817**23.**

At the 40 000 km (24 000 miles) service, only the calibrated nipple in the intake manifold, for the crankcase ventilation, should be cleaned. (For the B 18, replace the valve in the hose at the oil trap, remove the oil trap, clean.)

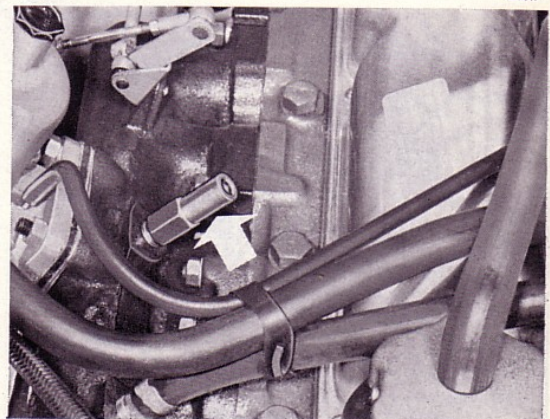
VOLVO  
104808

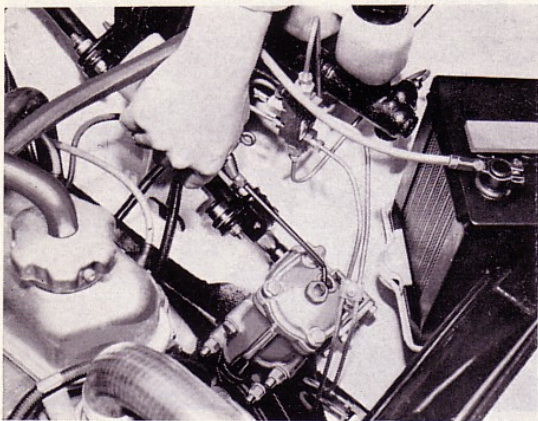
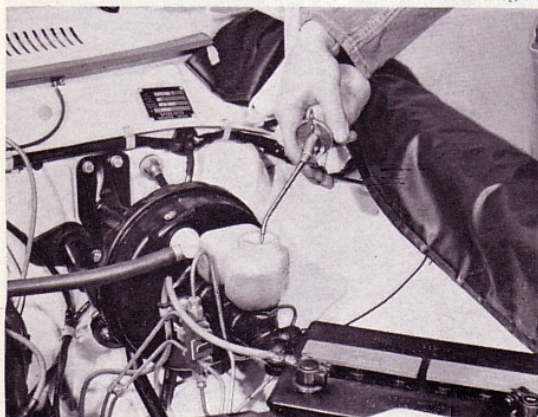
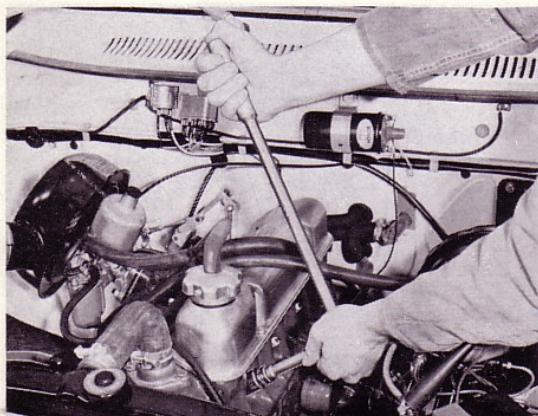
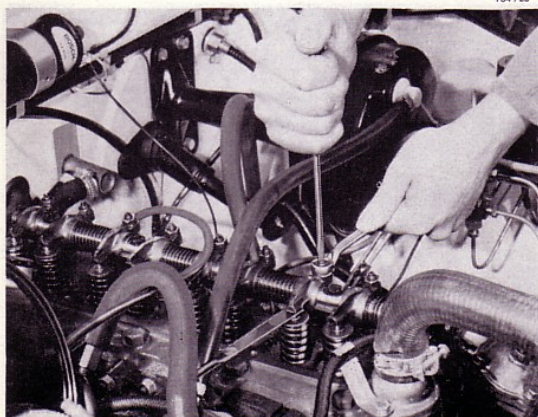
VOLVO  
104 721VOLVO  
104 722VOLVO  
104 723VOLVO  
104 724**24.**

Check and, if necessary, fill the steering box with oil.

**25.**

Check the oil level in the brake fluid container (also container for clutch if such is fitted). Fill with brake fluid SAE 70 R 3 if necessary.

**26.**

Remove the spark plugs. Clean the plugs and adjust the gap to 0.7—0.8 mm (0.028—0.032"). If necessary, change the plugs.

**27.**

Remove the rocker arm casing and adjust the valves as follows:

Crank the engine with a fixed spanner or sleeve on the crankshaft pulley bolt. Tighten until No. 4 cylinder (or No. 6 cylinder) exhaust valve closes, and No. 4 cylinder (or No. 6 cylinder) intake valve opens. Adjust the pulley to 0°.

Adjust valves Nos. 1, 2, 3, 5 (for 6 cyl., 1, 2, 3, 6, 7, 10) counted from the front.

(See "Specifications" for the gap for the particular engine in question.)

Crank the engine until No. 1 cylinder valves open and shut respectively. Adjust the pulley to 0°. Adjust valves Nos. 4, 6, 7, 8 (for 6 cyl., 4, 5, 8, 9, 11, 12).

**28.**  
 Wash the rocker arm casing and re-fit it. If necessary, change the gasket.

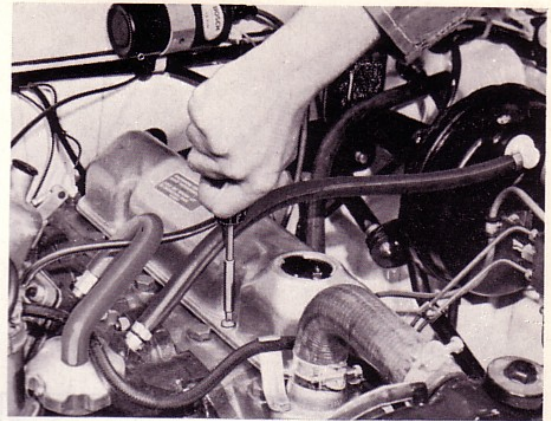

VOLVO 104 725

**29. \***  
 Wire in the starting contact between terminal 50 on the starter motor and B+ on the battery.

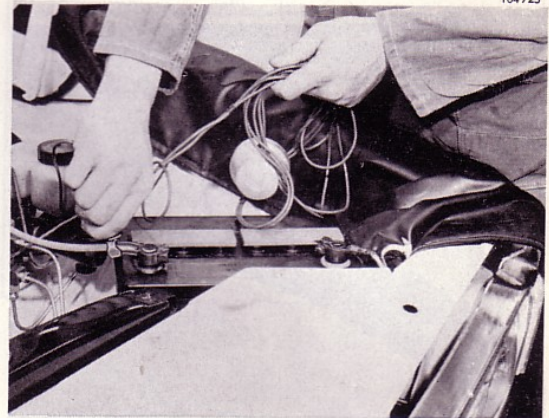

VOLVO 104 725

**30.**  
 Carry out a compression test.  
 Re-fit the spark plugs.  
 (Tightening torque: 3.5—4.0 kpm = 25—29 lb.ft.)

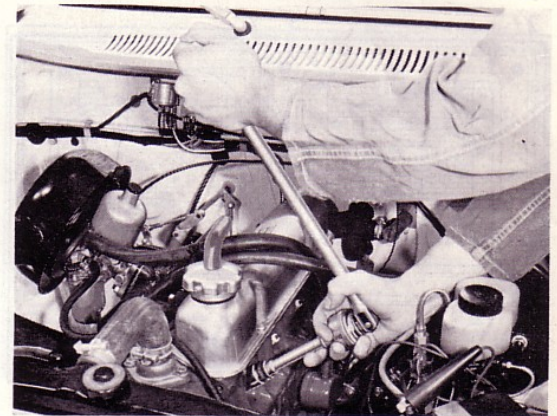

VOLVO 104 727

**31. \***  
 Connect the Volvo-Tester to the electrical system of the vehicle as shown in the adjacent wiring diagram. The ignition lead 1, from the centre hole in the distributor cap, is not connected to the pattern pickup.

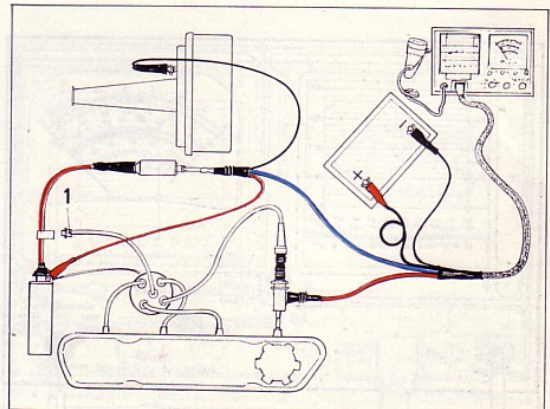

VOLVO 104 728

P

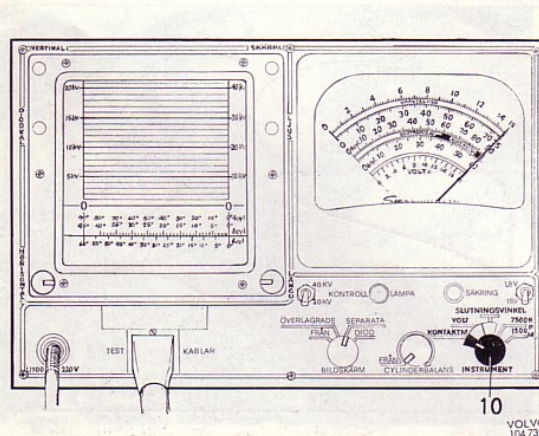
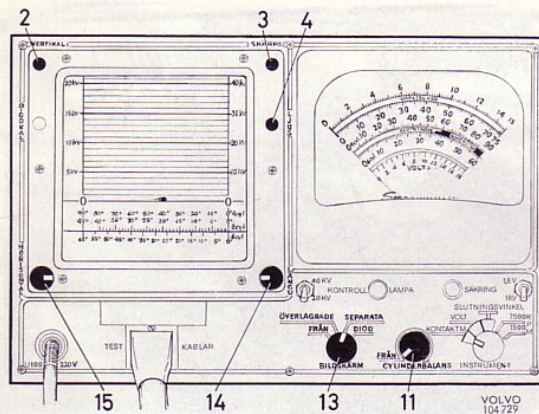
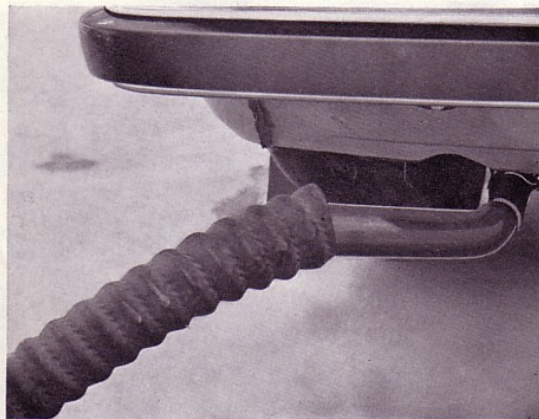

1-16

**32. \***

Turn the ignition key to driving position.

**33. \***

Connect exhaust hose.

**34. A. \***

Connect up the Volvo-Tester. Set PATTERN SELECTOR 13 to "PARADE". (Check to make sure that CYL. SELECTOR 11 switch is at "OFF". Point the white marks on controls 14 and 15 towards each other (basic position).

After the tester has been given a moment to become warm, a light spot will sweep across the screen. Check to make sure that this light spot follows the O-line. Otherwise adjust with control 2.

(If necessary, adjust focus and brightness with controls 3 and 4.)

**B. \***

Switch METER SELECTOR 10 to "DIST. RES." (black marking). Read off the meter. The pointer should be within the black block to the extreme right of the dwell angle scale. If the pointer remains at 0, then the breaker contacts are not closed. Crank the engine until the contacts close. (If the pointer still remains at 0, then the red test lead to the ignition coil must be incorrectly connected up.)

If the pointer is not within the black block at the extreme right, there must be excessive resistance across the breaker contacts. To trace the fault,

move the red test lead from terminal 1 on the ignition coil to the primary terminal on the distributor. If the needle swings to the correct value, there must be a fault in the lead or in the terminals between ignition coil and distributor.

If the reading remains unchanged, move the ground lead from the brake servo to the distributor housing. If the pointer changes to the correct value, there must be poor contact between the various components, for example, engine - body, engine - distributor. If the reading is still incorrect, the fault must be inside the distributor (breaker contacts or connections).

**C. \***

Check to make sure that the flip switch 9 is at "18 V". Set METER SELECTOR 10 to "VOLT" (green marking). Read off the battery rest voltage on the green scale of the meter. The voltage should be minimum 12.0 volts. If it is lower than this, check the battery and charge or replace it.

**D. \***

Turn over the engine with the starter motor. Read off the start voltage of the battery on the meter. The voltage should be minimum 9.5 volts. If it is lower than this, the reason may be a poor battery or faulty starter motor.

If the starter motor speed is below normal, this may be due to high resistance in the leads or starter motor, or excessive mechanical resistance in the engine.

If the starter motor speed is uneven, this may be due to a faulty starter motor, faulty ring gear on the flywheel or uneven engine compression.

**E. \***

Set the flip switch 12 to "40 KV". Turn over the engine with the starter motor and read off the ignition coil start voltage on the oscilloscope screen. Read off the graduation on the right-hand side of the screen. The voltage should be minimum 20 KV. If lower than this, the reason may be a faulty ignition coil faulty condenser, too small dwell angle or voltage drop in the feed lead to ignition coil. After completing this test, flip the switch 12 to 20 KV.

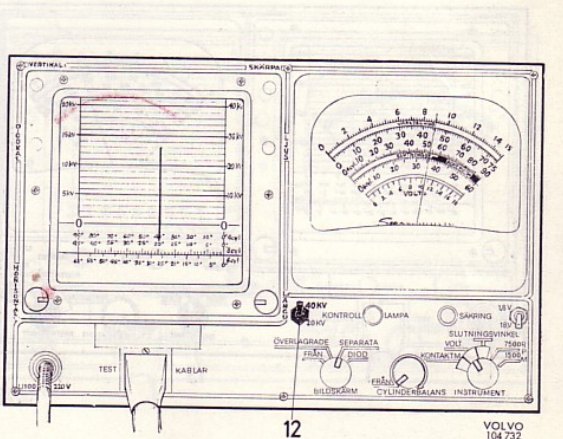
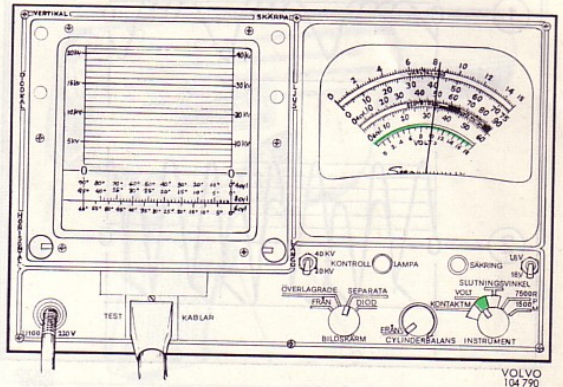
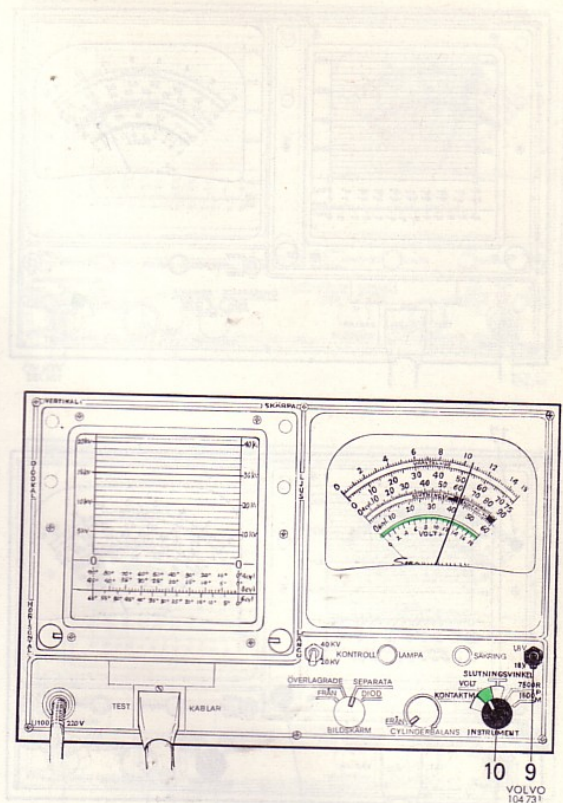

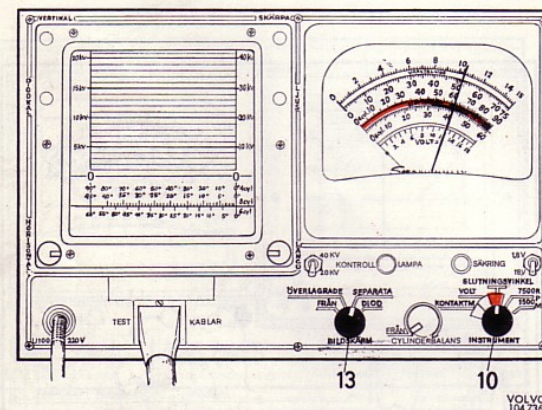
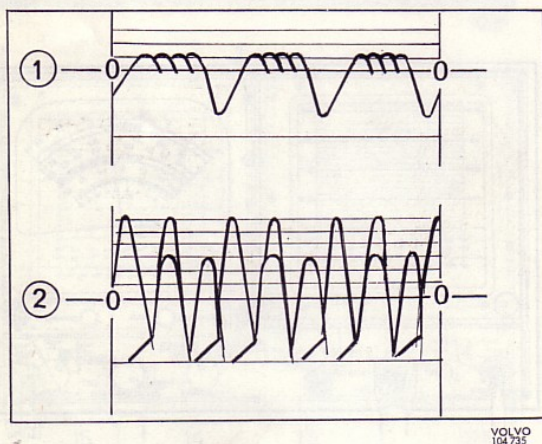
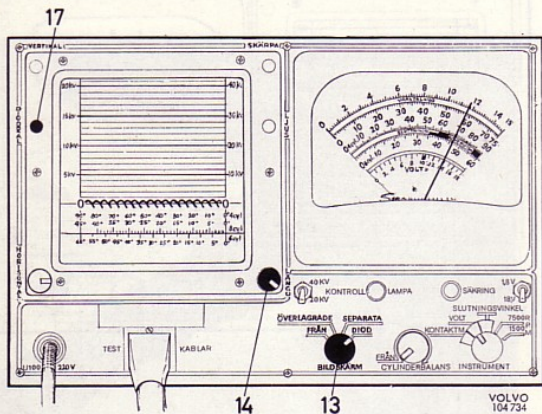
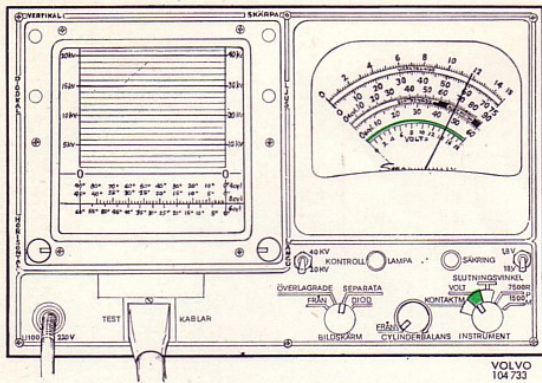

**F. \***

Connect the firing lead from the centre outlet of the distributor to the socket in the pattern pickup. Start the engine and run it to about 2500 r.p.m. Check that the generator is charging and that the voltage is between 13.0—15.0 volts. If this is not the case, carry out the charging check outlined in the respective service manual. (For vehicles with an alternator, first carry out the test, G, in order to make sure that the diodes in the alternator are not damaged.) Check also that the needle does not fluctuate. If it fluctuates, for example, when increasing the speed of the engine, quite probably the reason is that the generator pulley belt is insufficiently tensioned so that the generator slips.

**G. \***

**This point applies only to vehicles with alternator.** Run the engine to about 2500 r.p.m. Switch PATTERN SELECTOR 13 to "ALT. TEST". Turn control 17, "ATA GAIN", and control 14, "PATTERN LENGTH", clockwise as far as possible. Check to make sure that the wave form on the screen is continuous and does not show any conspicuous deviations.

If the wave form is not continuous but shows tops and bottoms, see adjacent illustration, one of the diodes in the generator is faulty. Single upward lines in the pattern arise from the firing system and not from the generator. Restore control 14 to basic position after completing test.

**H. \***

Set PATTERN SELECTOR 13 to "PARADE" and METER SELECTOR 10 to "DWELL" (red marking). Let the engine idle and read off the dwell angle. For the B 18 and B 20 engines, the needle should point to the upper black block in the middle of the dwell angle scale, and to the lower black block for the B 30 A engine. (B 18, B 20: 59—65°, B 30 A: 37—43°). If the dwell angle is faulty, this will be due to a faulty distributor breaker gap or incorrectly installed distributor breaker contacts.

I. \*

Slowly raise the speed of the engine to about 2500 r.p.m. and observe the instrument at the same time.

The dwell angle may not vary more than 2°.

If it varies more than 2°, disconnect the hose to the vacuum governor. Again raise the speed. If the variation is less with the vacuum governor disconnected, the fault is probably due to a loose or worn breaker plate. If the variation remains unchanged with the vacuum governor disconnected, the fault is probably due to a worn distributor shaft or worn bushes on the distributor shaft.

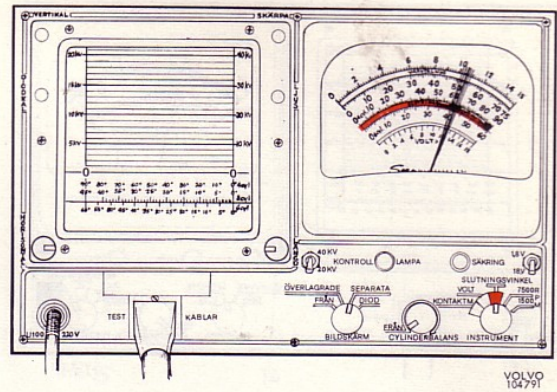

VOLVO 104791

J. \*

Set METER SELECTOR 10 to "7 500". Disconnect the vacuum governor. Run the engine at the speed according to the "Specifications". Check to make sure that the basic firing position is the correct one.

The ignition setting lamp can be used in 2 ways. One, it can be used as a normal ignition setting lamp. In the lamp at the graduation on the pulley, squeeze button 1 on the handle, and read off the firing setting on the pulley. (Check to make sure that button 2 on the lamp is turned anti-clockwise as far as possible.)

Another way to use the lamp is to read off the firing position on the meter 3 located in the butt of the lamp. In this case, the lamp is pointed at the pulley, button 1 squeezed and button 2 turned clockwise until the 0-marking on the pulley is exactly opposite the mark on the transmission casing. Read off the meter. This last-mentioned method **must** be used for the next point when the centrifugal governor is checked at 2500 r.p.m., since the pulley is graduated only to 30° B.T.D.C.

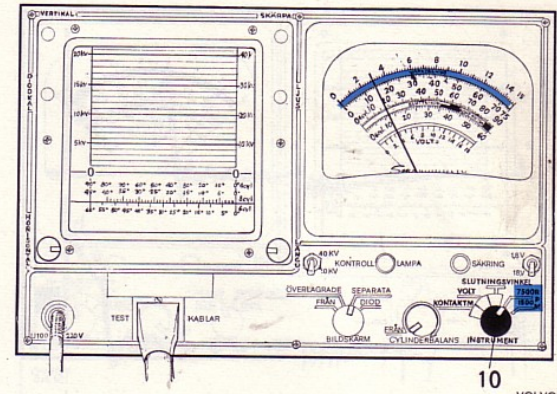

10

VOLVO 104737

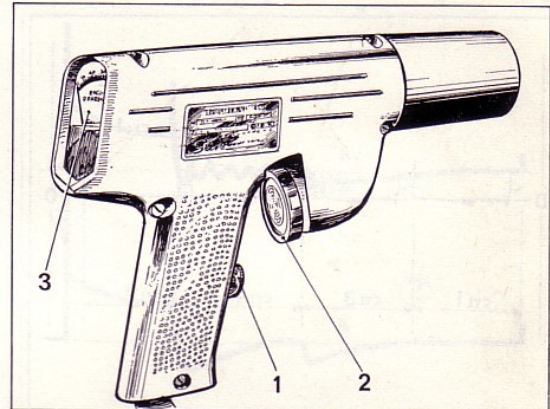

VOLVO 104738

K. \*

Run the engine to 2500 r.p.m. and read off the firing setting. If the value is not according to the "Specifications", the centrifugal governor in the distributor must be faulty.

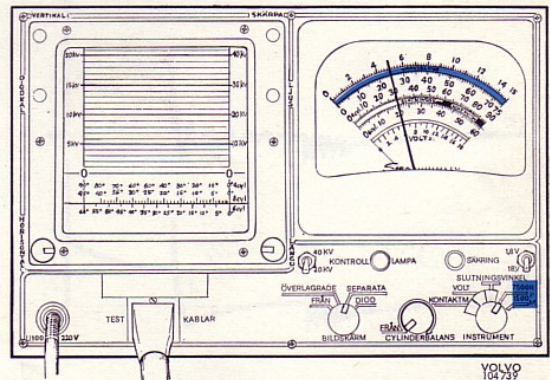

VOLVO 104739

P

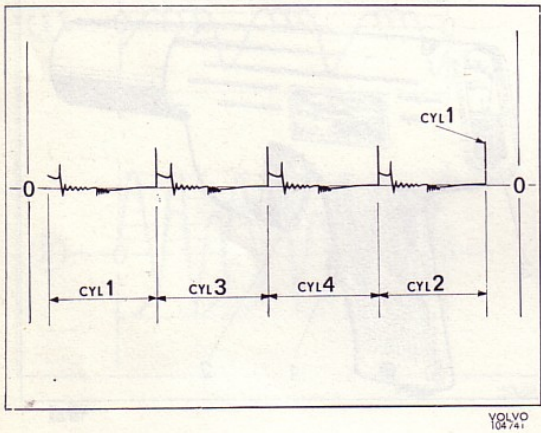
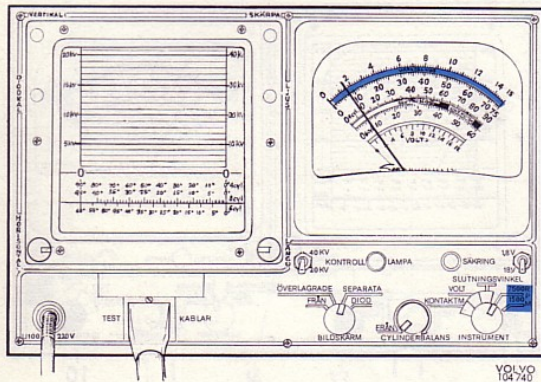
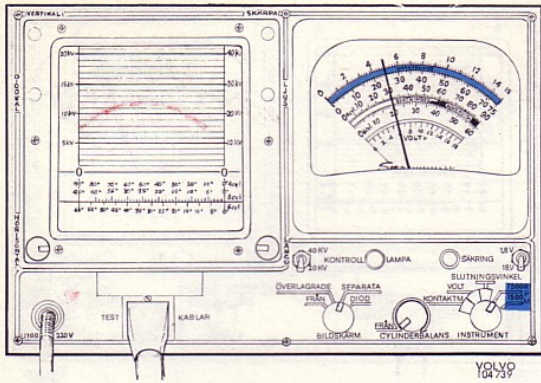

**L. \***

**Point L applies only to vehicles with positive vacuum control** (B 18 A and D, B 20 A, B 30 A).

Connect the vacuum governor and adjust the speed to 2 500 r.p.m.

Read off the firing setting and compare with the reading according to K. The value should increase considerably when the vacuum governor is connected. If it does not do so, the vacuum governor or the hose connection from the engine must be defective.

**M. \***

**Point M applies only to vehicles with negative vacuum control** (B 20 B, B 20 E, B 30 A).

Run the engine at 600—800 r.p.m. (B 20 E: 700—800 r.p.m.).

Connect the vacuum governor and read off the firing setting. Check to make sure that the value is within the value given in "Specifications". If the vacuum governor does not lower the firing setting sufficiently, the vacuum governor or the hose connection is defective.

**N. \***

Adjust the engine speed to 1 500 r.p.m.

Adjust in the curve for all cylinders on the screen with the help of controls 14 and 15. (Begin with the basic position.)

The curve shows the cylinders in firing order from left to right (B 18, B 20: 1-3-4-2, B 30 A: 1-5-3-6-2-4), **but** the firing line for No. 1 cylinder is **not** included with the other part of the curve for No. 1 cylinder. It is at the extreme right on the screen.

Check the polarity of the ignition coil. If the ignition coil is connected up properly, the curve will be similar to that shown in the illustration adjacent. If the ignition coil is incorrectly connected up or it is the wrong type, the curve will be inverted.

Read off the firing voltage for all cylinders. The firing voltage should be 4—8 KV. The variation from cylinder to cylinder may not be greater than 1.5 KV. If the firing voltage is too high for all the cylinders, the following may be the faults: poor spark plugs, faulty interference suppressors, excessive rotor gap, faulty distributor cap, faulty rotor, faulty ignition coil or weak fuel mixture. If the firing voltage is uneven (variation larger than 1.5 KV) it may be due to the following: poor spark plugs, faulty interference suppressors, broken firing leads, cracked or faulty distributor cap.

**O.**

Points P—S are normally checked with all the cylinders represented on the screen, but individual cylinders can be represented and adjusted in detail if necessary. Such adjustment of the scope curve will be done with controls 14 and 15.

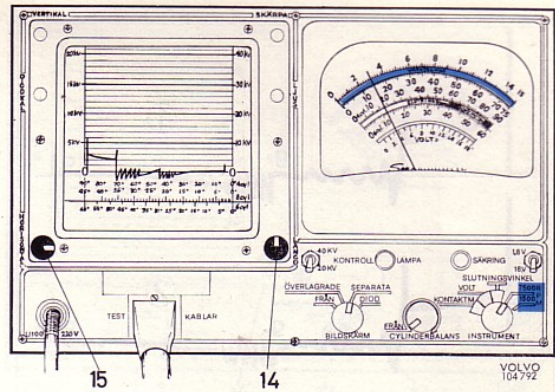

**P.**

Checking the spark line:

Normally the spark line should look like line 1 opposite. The voltage difference (height) between **d** and **e** may not exceed 1.5 KV.

If the spark line inclines abnormally, as is the case in Fig. 2, this may be due to large resistance in the firing leads, faulty interference suppressors, faulty rotor, poor connection of firing leads to ignition coil and distributor cap. If the spark line becomes irregular, this may be due to flashover caused by fault in spark plug lead, etc., or worn engine.

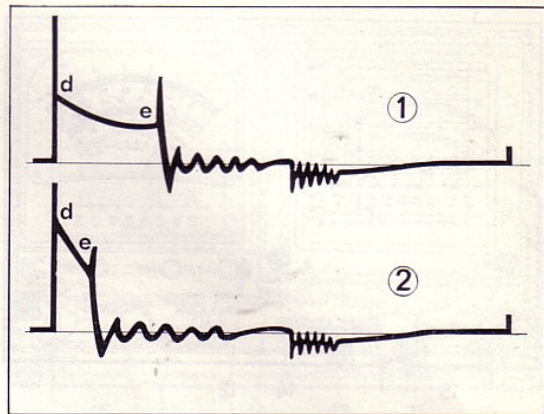

VOLVO 104742

**Q.**

Checking the ignition coil:

Check that positive oscillations appear at **f** and **h**, see Fig. 1.

If there are no oscillations, as shown by Fig. 2, the ignition coil is faulty.

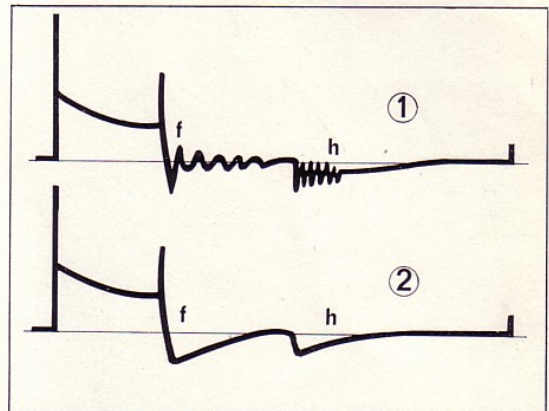

VOLVO 104743

**R.**

Checking the condenser:

Check to make sure that there are distinct oscillations at **f** and that the angle at **a** is 90°, see Fig. 1.

If there are oscillations at **h** but none at **f**, this may be due to a leaking condenser, see Fig. 2. If no 90° angle is formed, this may be due to excessive series-resistance in the condenser.

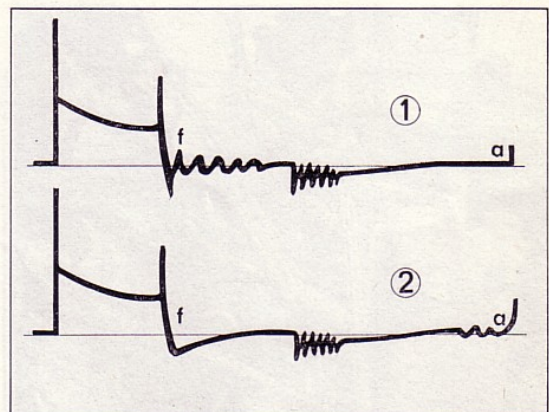

VOLVO 104744

P

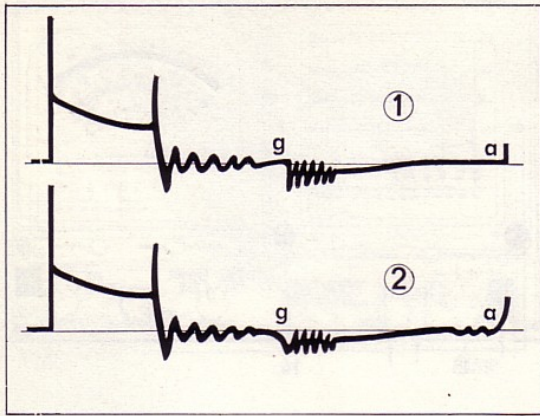

VOLVO  
104745

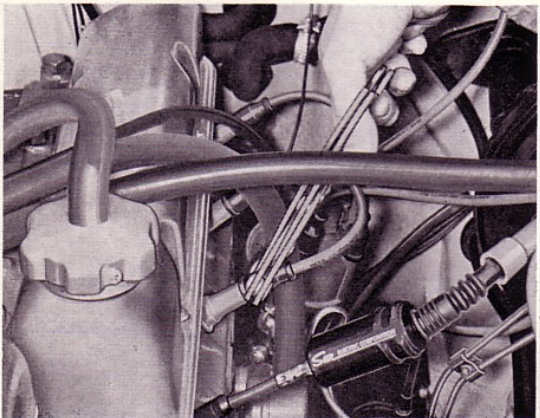
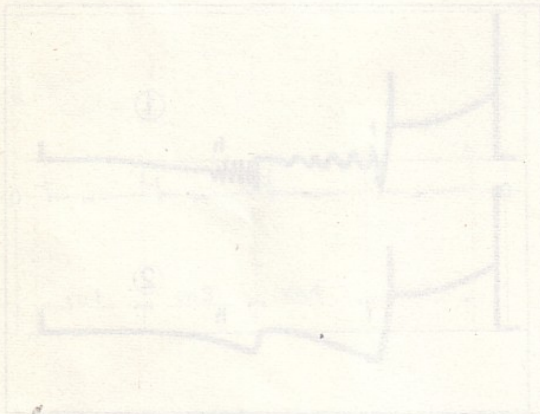
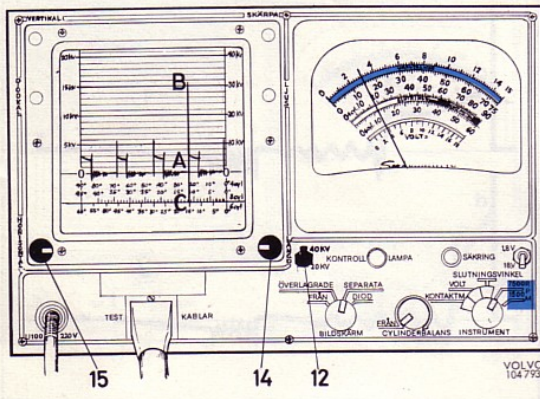

VOLVO  
104793

**S. \***

Checking the distributor breaker contacts:  
Check to make sure that a 90° angle is formed at **g** and **a**, see Fig. 1.  
If the angle is not 90°, see Fig. 2, this may be due to faulty distributor breaker contacts (dirty or burnt).

**T. \***

The maximum firing voltage of the ignition coil and the isolation in the secondary circuit are checked by means of the following test:

Adjust the curve for all the cylinders on the screen with the help of controls 14 and 15. (Begin with the basic position.)

Flip switch 12 to "40 KV".

Use the isolated pliers belonging to the Volvo-Tester and disconnect the firing lead from the spark plug of No. 2 cylinder. Hold the lead so that no spark can jump over to the engine block, so that a breakage in the high-tension circuit is formed.

Read off the maximum firing voltage of the ignition coil on the screen. Read the graduation on the right-hand side of the screen. The maximum firing voltage should be minimum 25 KV. If it is lower than 25 KV, this may be due to the following: voltage drop in the primary circuit, faulty ignition coil or faulty secondary isolation.

Check to make sure that line **a—c** is 1/3—1/2 of the maximum firing voltage.

Re-fit the firing lead for No. 2 cylinder and remove the other firing leads one at a time, except the one for **No. 1 cylinder**, and read off the secondary isolation **a—c**.

The length of the **a—c** line should be the same for all cylinders. If the line is short or non-existent for one or several cylinders, the fault is in the cylinder cap or in the firing lead to the particular cylinder concerned.

If the line is short or non-existent for all cylinders, the fault is probably in the coil, firing lead from the coil to distributor cap or rotor in the distributor.

**U. \***

Set switch 12 to "20 KV". Adjust PATTERN SELECTOR 13 to "SUPERIMPOSED". Adjust the curve with controls 14 and 15 so that it covers the screen.

Check that the dwell angle variation between the various cylinders does not exceed  $2^\circ$  at **g** and **a**. If the variation is excessive, this may be due to a worn breaker cam, worn distributor shaft or loose ignition plate.

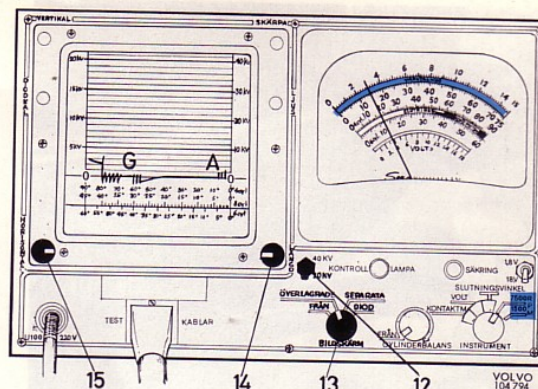
**V. \***

Set PATTERN SELECTOR 13 to "PARADE" and METER SELECTOR 10 to "1500". Adjust the engine speed to exactly 1 500 r.p.m.

Adjust the curve on the screen so that all cylinders are included with controls 14 and 15.

Short-circuit No. 1 cylinder with the short-circuiting probe and read off the reduction in speed. Remove the short-circuiting probe and allow the engine to increase in speed.

Then turn control CYL. SELECTOR 11, slowly clockwise until the descending loop removes the firing line for No. 3 cylinder (for B 30 A, No. 5 cylinder). Read off the reduction in speed.

Move the descending loop further a bit so that it comes between the firing lines for cylinders Nos. 3 and 4. (For B 30 A, cylinders Nos. 5 and 3.) Allow the engine to increase in speed again and then carry out the same test for the other cylinders. If the difference in speed reduction is greater than 200 r.p.m. between the various cylinders, probably the fault is a mechanical one in the engine (uneven compression, faulty carburettor setting).

Turn back control CYL. SELECTOR 11 to "OFF" position after completing the test.

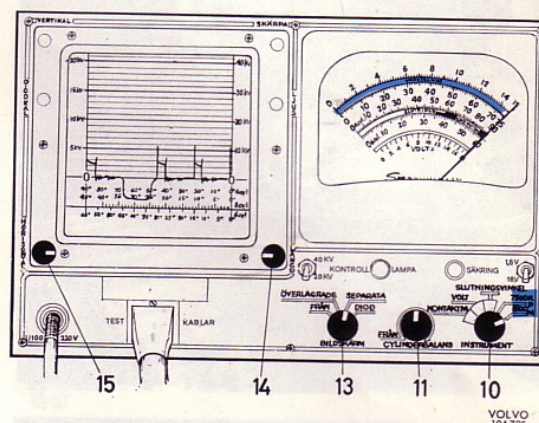
**X.**

Adjust to the right idling speed for the engine, see "Specifications".

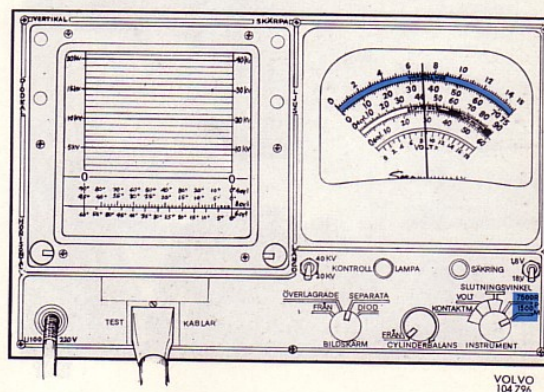

P

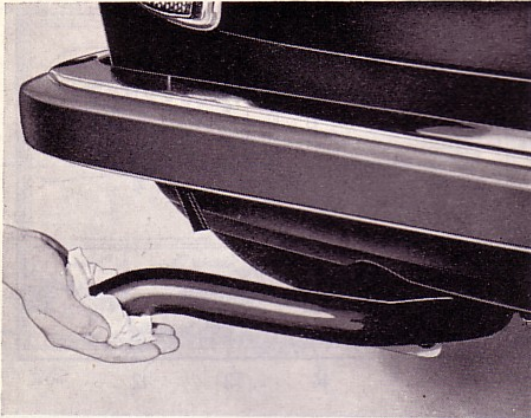

VOLVO  
104 746

35. \*

Remove the exhaust hose and block the exhaust pipe with a rag or similar to check the exhaust system for leakage.

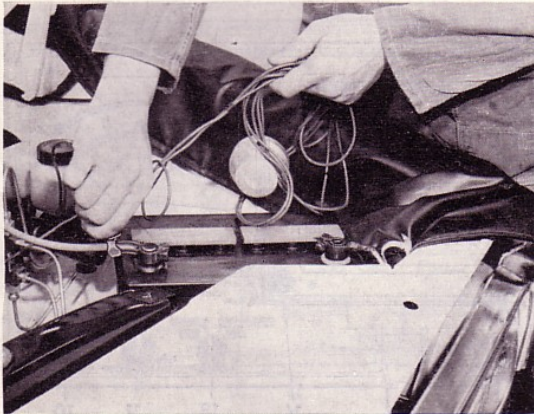

VOLVO  
104 726

36. \*

Stop the engine by switching off the ignition. Remove the leads from the instrument(s). Remove the starter contact.

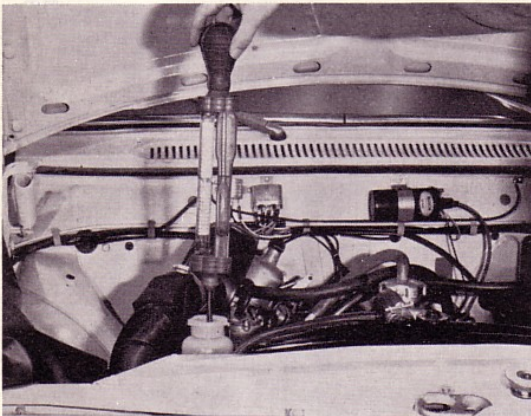

VOLVO  
104 747

37.

Check the freeze resistance of the coolant. (This should be  $-35^{\circ}\text{C} = -31^{\circ}\text{F}$  with a 50/50 mixture of ethylene glycol and water.)

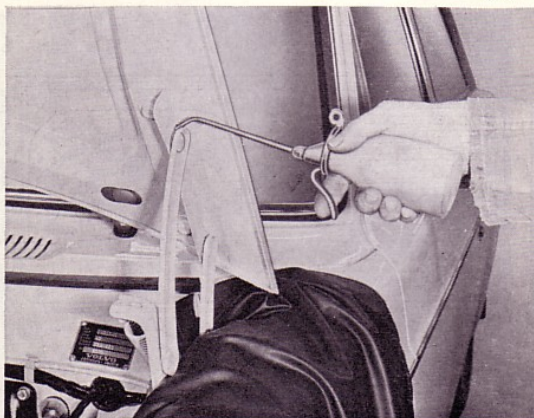

VOLVO  
104 748

38.

Lubricate the hinges with oil.

39.

Lubricate the distributor shaft by filling the lubricator with engine oil.  
Do not forget to turn back the lubricator so that the hole is covered.

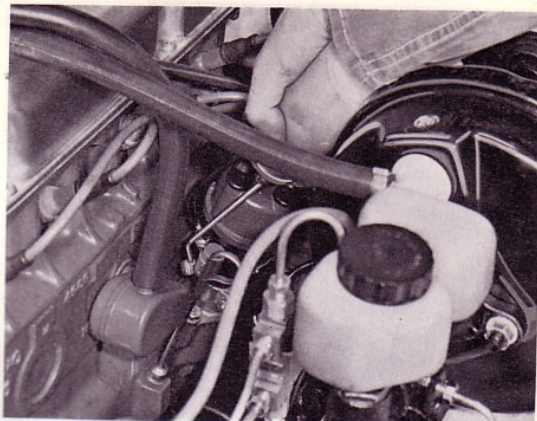
VOLVO  
104749

40. \*

Check the front shock absorbers by rocking the front end up and down.

VOLVO  
104750

41.

Lubricate the hinges of the left-hand doors and the door stops with grease and oil respectively.  
Check the door stops and lock plates.

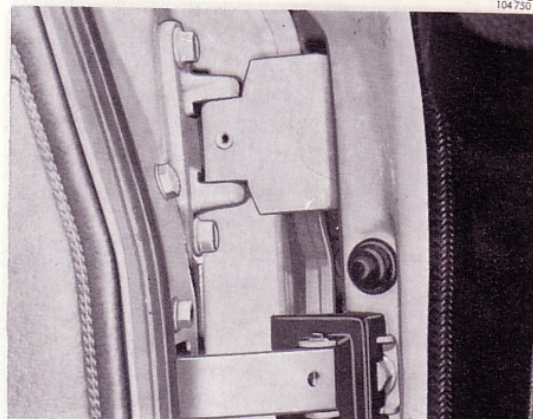
VOLVO  
104813

42.

Lubricate the luggage compartment lid hinges with oil.

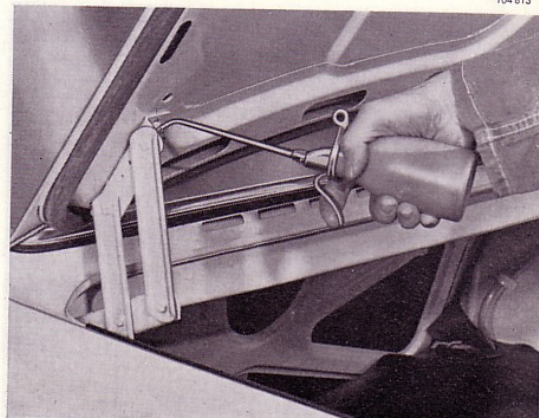
VOLVO  
104751

P

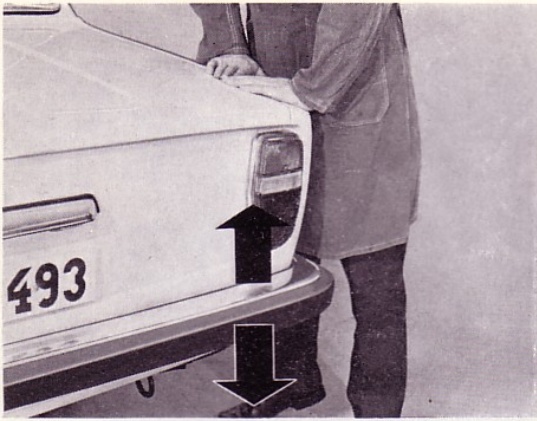

VOLVO  
104752

**43. \***

Check the rear shock absorbers by rocking the rear end up and down.

**44.**

Lubricate the hinges of the right-hand doors and door stops with grease and oil respectively. Check the door stops and locking plates.

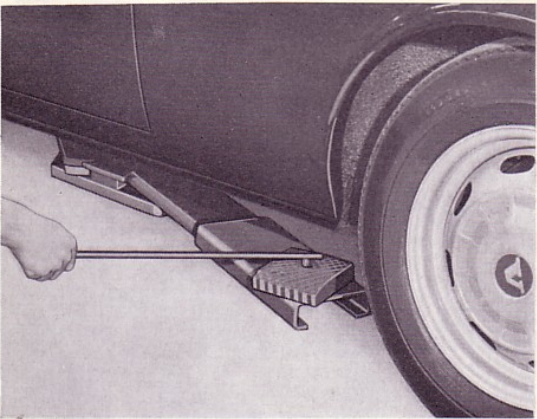

VOLVO  
104753

**45. \***

Install the lift plates for the lift. Raise the lift so that the front wheels come off the floor.

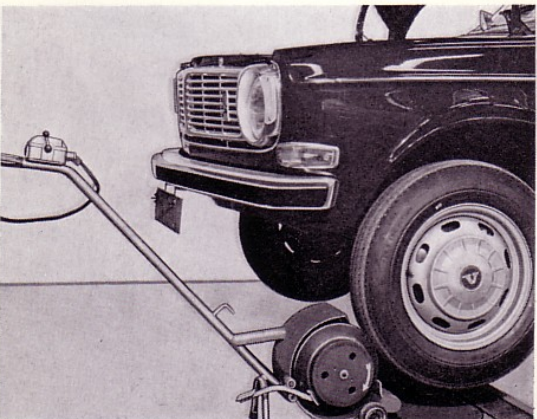

VOLVO  
104754

**46. \***

Check the bearings of the front wheels and balancing by spinning the wheel with a wheel balancer.

**47. \***

Raise the lift to the intermediate position.

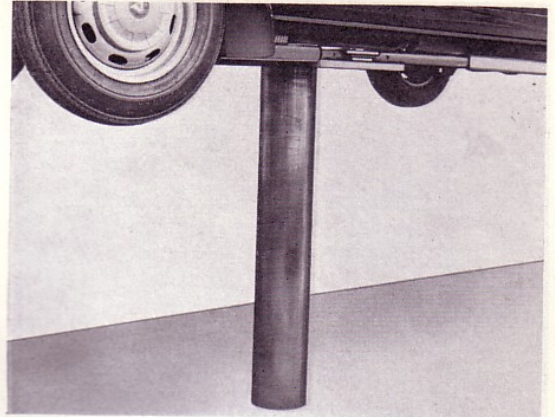
**48. \***

Place props under the lower wishbones and carefully lower the lift until the front lift heels for the lift release from the body.

Check front wheel bearings, ball joints for front end (lower ball joints are checked with the help of strong polygrip pliers), steering rods, rubber covers for ball joint and steering rods, springs and shock absorbers.

Raise the lift and remove the props.

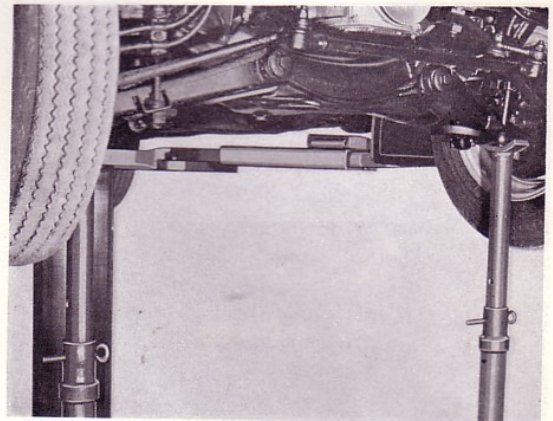
**49.**

**Points 49—52 apply only to vehicles with drum brakes front.**

Remove the front wheels and brake drums.

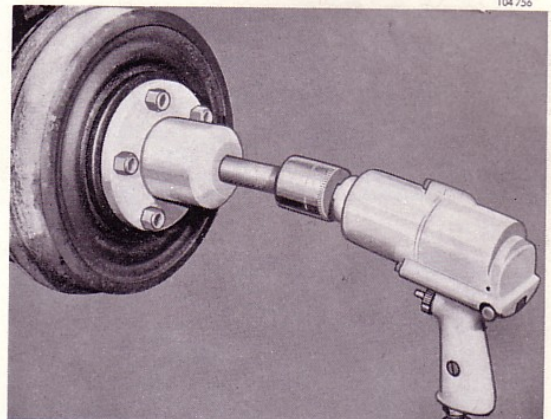
**50.**

Check the brake linings and wheel cylinder units. Clean the brake shoes and pads.

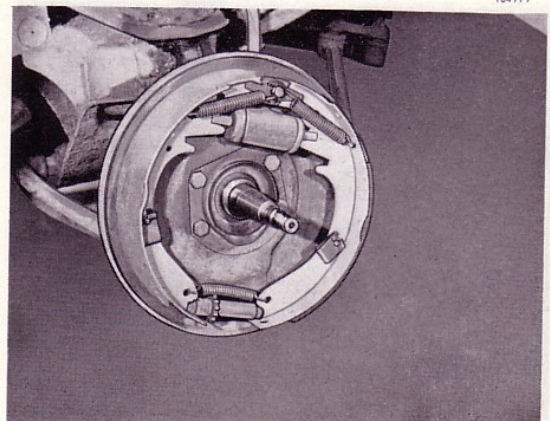

P

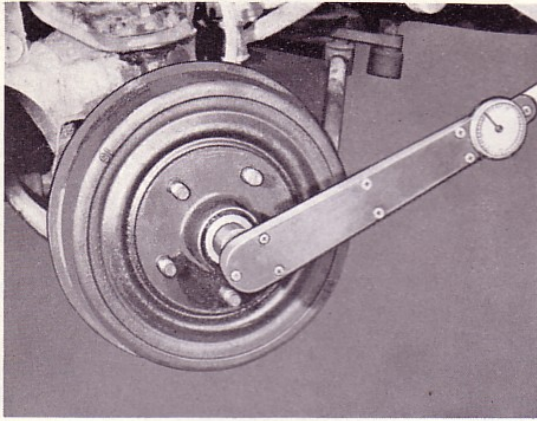

VOLVO  
104781

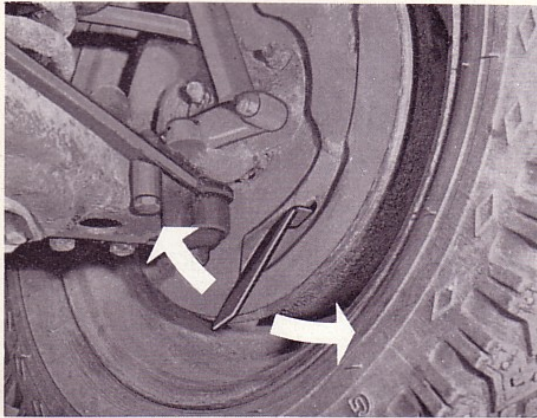

VOLVO  
104782

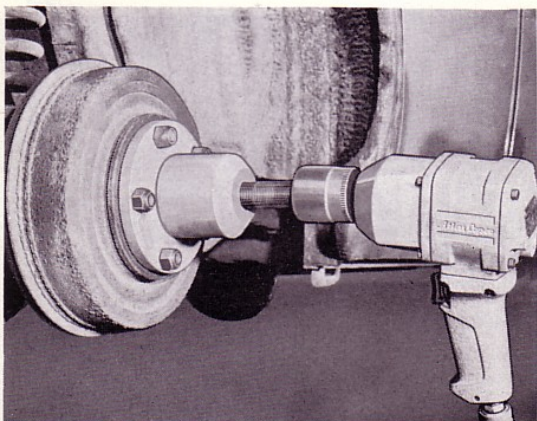

VOLVO  
104783

**51.**

Fit the brake drums and front wheels. Adjust the front wheel bearings by tightening the nut to a torque of 7 kpm (51 lb.ft.). Then slacken the nut 2 hex flats. If the nut recess does not coincide with the split pin hole in the spindle, loosen the nut further to enable the split pin to be fitted.

**52.**

Adjust the brake shoes as follows: Remove the rubber seal on the inside of the brake backing plate. Rotate the wheel in its normal direction of rotation while applying the brake shoes against the brake drum. This is done by moving the tool or screwdriver upwards. When it is possible to rotate the wheel by hand, stop applying the brake shoes to the brake drum and slacken the adjusting screw 12 notches. Check to make sure that the wheel rotates freely and fit the rubber seal.

**53.**

Lower the front end. (Only for certain types of lifts.)

**54.**

Lower the rear end. (Only for certain types of lifts.)

**55.**

Points 55—59 apply only to vehicles with drum brakes rear. Remove the rear wheels and brake drums.

**56.**

Check to make sure that the parking brake is not jammed by rust or damaged and that the rubber covers are without fault.

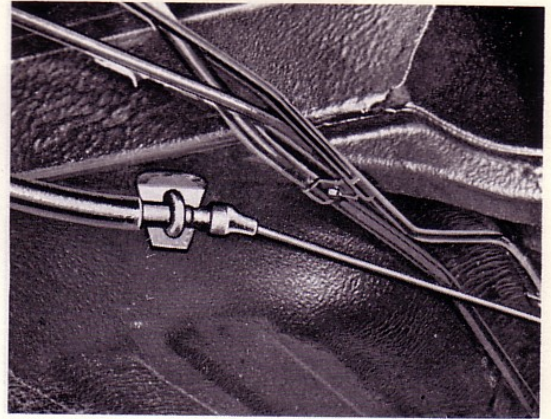

VOLVO 104 764

**57.**

Check the brake linings and wheel cylinder units. Clean brake drums, brake shoes and backing plates.

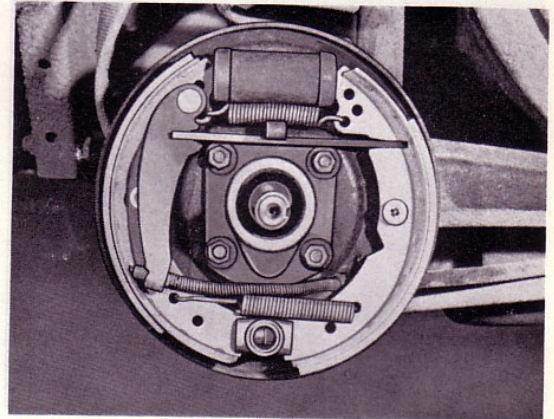

VOLVO 104 765

**58.**

Fit the brake drums and wheels. Tighten the centre nut to a torque of 23—32 kpm (166—231 lb.ft.).

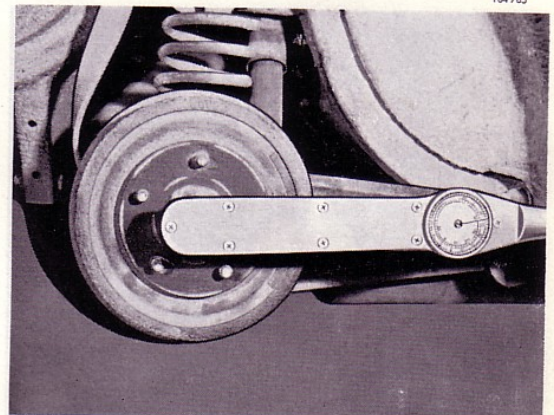

VOLVO 104 766

**59. a.**

Adjusting the footbrake.  
For vehicles with drum brakes, see point 52. For vehicles with disc brakes front adjust as follows: Rotate the wheel in its normal direction of rotation. Apply the brake shoes with special tools SVO 2548. Turn the tool clockwise until it is just possible to rotate the wheel by hand, after which slacken 4 "notches" and check to make sure that the wheel rotates freely.

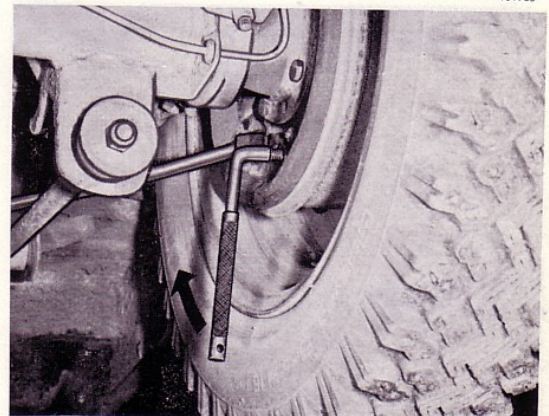

VOLVO 104 767

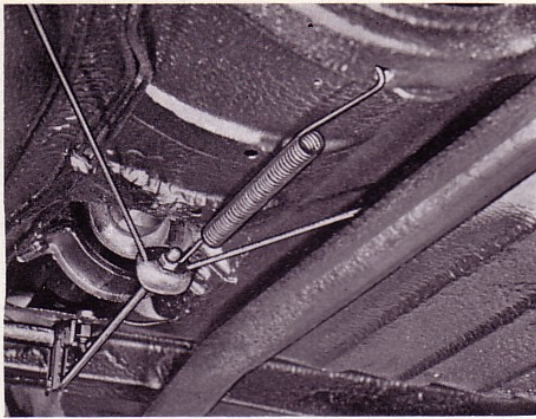

VOLVO 104 808

**59. b.**

Check, and if necessary, adjust the parking brake so that it provides adequate braking power at the 3rd or 4th notch. Adjustment is made by moving the block on the pull rod.

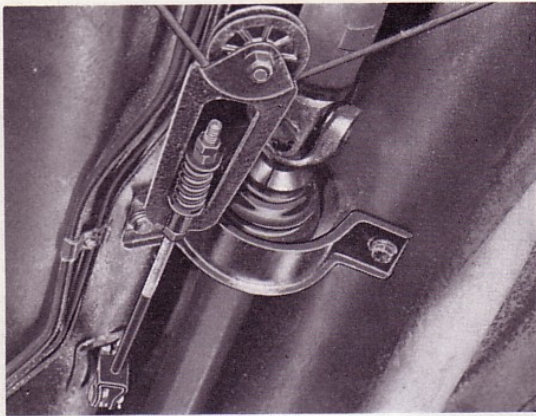

VOLVO 104 809

**60.**

**Points 60—64 apply only to vehicles with disc brakes on rear wheels.**

Check to make sure that the parking brake cable is not stuck by rust or damaged and that the rubber covers on the cable are without fault.

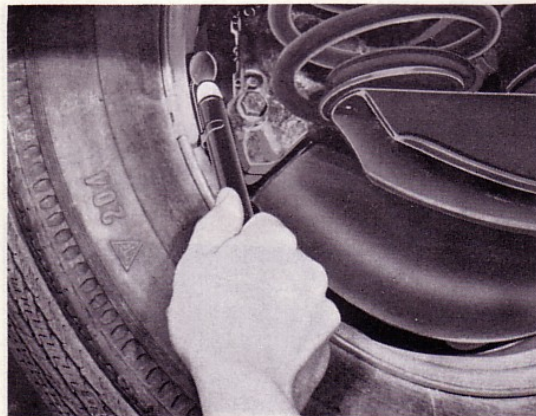

VOLVO 104 810

**61. \***

Check the brake pads and calipers on the rear wheels with the help of a lamp with mirror.

**62.**

**Points 62, 63 and 64 are only carried out when the parking brake has to be adjusted.**

Remove the rear wheels.

**63.**

Tighten the parking brake. Fit SVO 2742 over the return spring. Release the parking brake to take the load off the return spring. Remove the lock pin so that the lever will be free from the cable through the brake backing plate.

Adjust the drum so that its hole comes opposite the teeth of the adjusting screw. Apply the shoes with a screwdriver. When it is just possible to rotate the drum, slacken the adjusting screw 4—5 teeth. If the shoes "drag", slacken the screw a further 2—3 teeth. Only very light "dragging" is permitted. Repeat this procedure with the other wheel.

Connect the parking brake cable to the levers. Remove the SVO-tools.

Check to make sure that full braking effect is obtained with the parking brake drawn to the 3rd—4th notch. If otherwise, adjust with the pull rod.

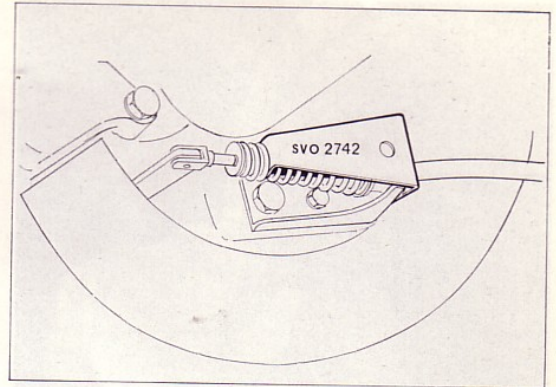
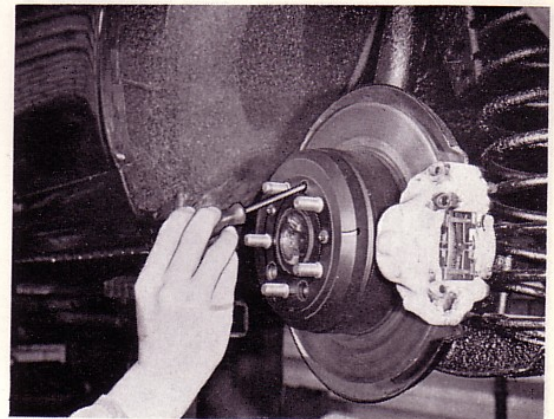
VOLVO  
104759VOLVO  
104758**64.**

Fit the rear wheels.

**65.**

Lower the rear end. (Only for certain types of lifts.)

**66. \***

Raise the lift to the upper position.

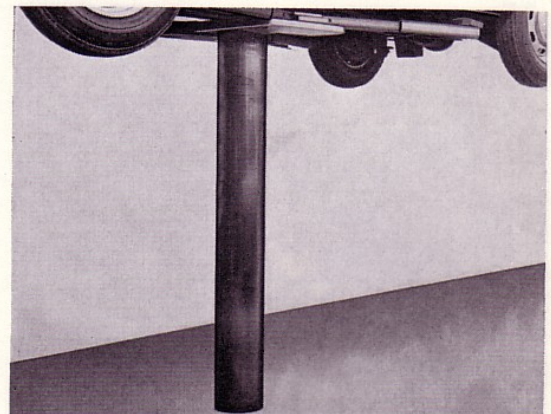
VOLVO  
104759

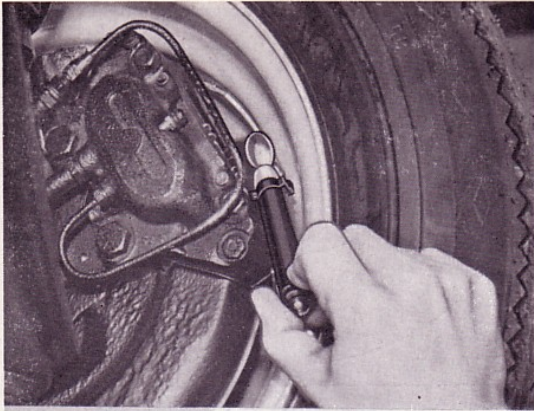
VOLVO  
104757**67. \***

**Point 67 applies only to vehicles with disc brakes front.**

Check the brake pads and brake calipers on the front wheels with the help of a lamp with mirror.

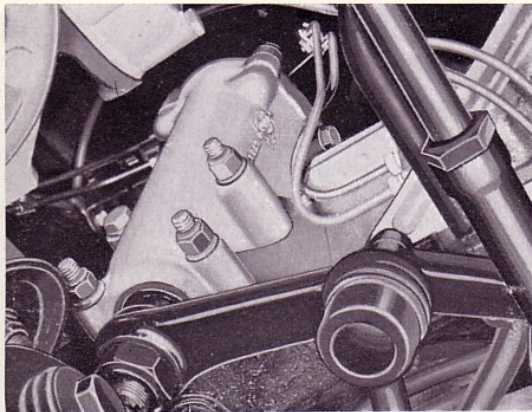
VOLVO  
104814**68.**

Check the steering box for oil leakage.

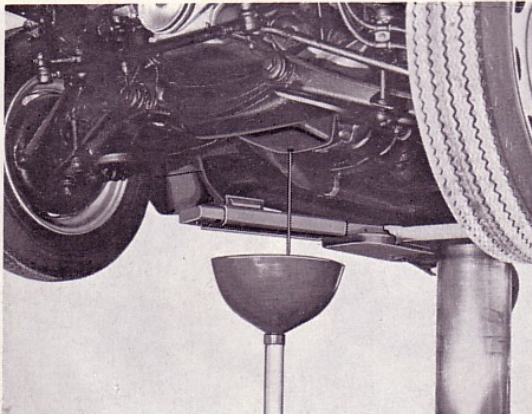
VOLVO  
104760**69. \***

Check the engine for oil leakage.

Drain the engine of oil.

(Do not drain the engine oil during the Volvo test.)

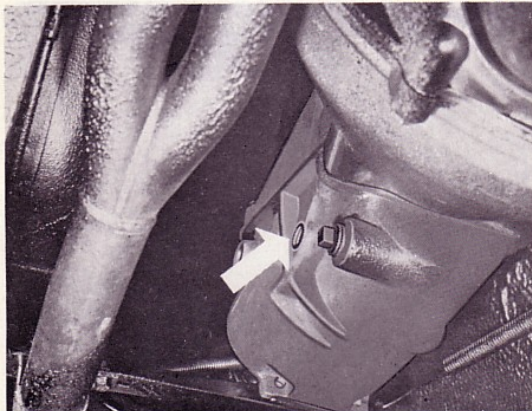
VOLVO  
104761**70. \***

Check the gearbox for oil leakage.

Check the oil level in the gearbox. Fill with oil if necessary.

Change the oil in the gearbox at the 40 000 km (24 000 miles) service. N. B. Does not apply to BW 35.

(Only external check during Volvo test.)

**71.**  
Check, adjust if necessary, the clutch fork play to 3—4 mm (0.12—0.16").

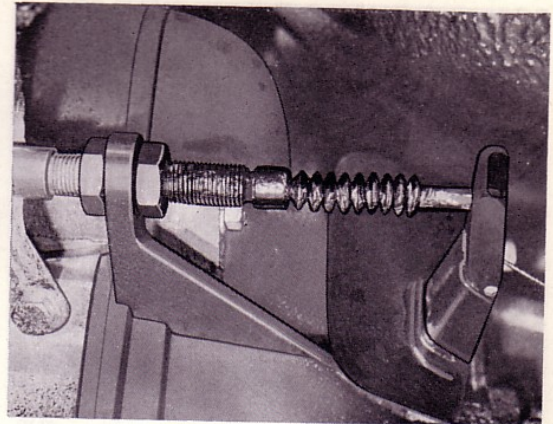

VOLVO 104762

**72. \***  
Check brake pipes, brake hoses and fuel pipes for leakage. Check also their mountings and for any damage.

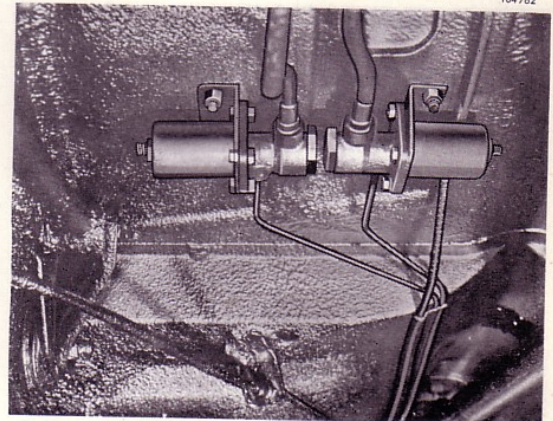

VOLVO 104763

**73. \***  
Check the universal joints with flanges and their bolts.  
Check the intermediate bearing mounting.

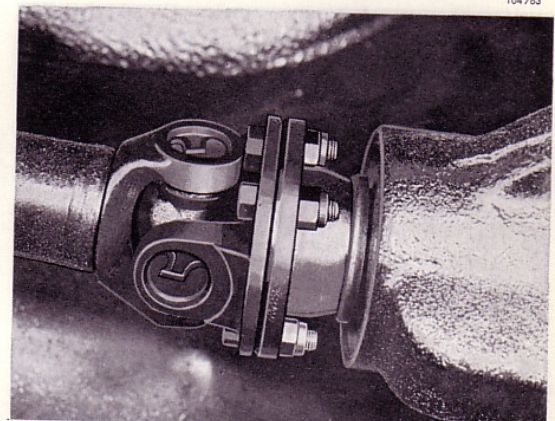

VOLVO 104764

**74. \***  
Check the final drive for oil leakage.  
Check the oil in the final drive. Fill with oil if necessary.  
(Only external control during Volvo test.)

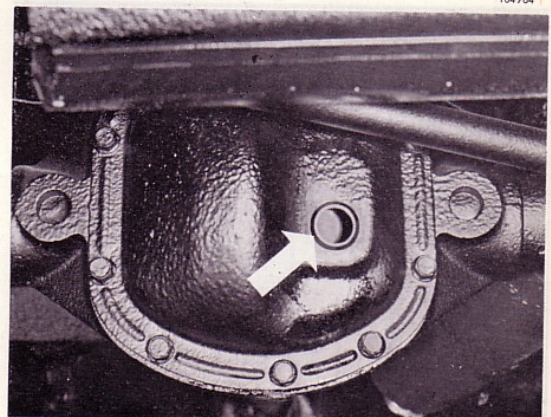

VOLVO 104765

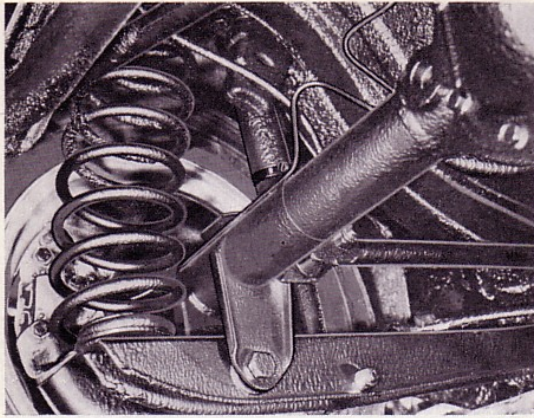
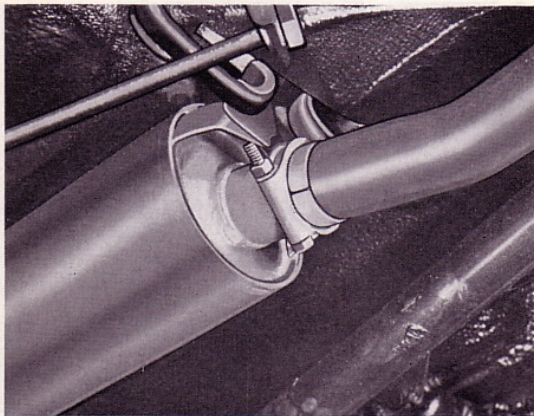
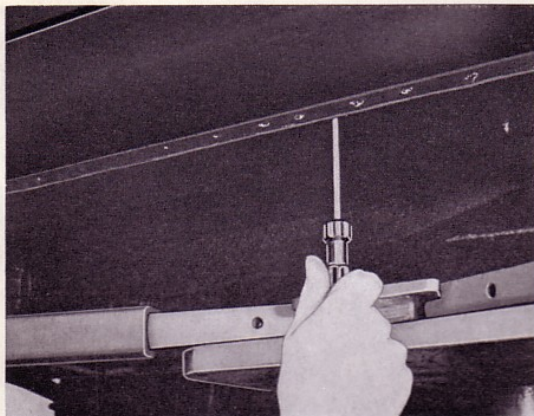
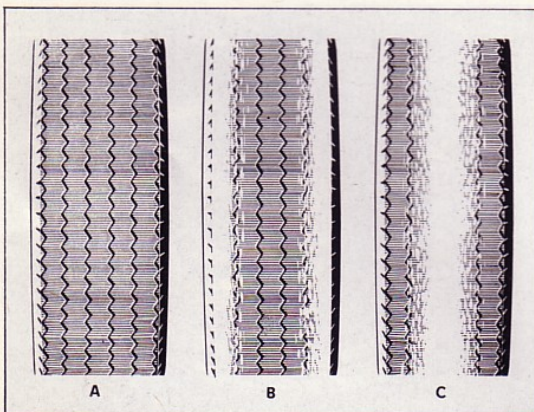
VOLVO  
104766VOLVO  
104767VOLVO  
104768VOLVO  
104769**75. \***

Check the rubber bushes on the rear end arms and rods.

Check shock absorbers, springs, mudflaps and, if fitted, stop band.

**76. \***

Check the mounting of the exhaust system and for any corrosion damage.

**77. \***

Check the underbody for rust and mechanical damage.

Check to make sure that the drain holes of the bottom rails are not blocked.

**78. \***

Check the tyre tread depth wear and tyre combination.

The tread depth should be minimum 1 mm (1/32") at the most worn part of the tyre.

The tyre tread on the front wheels must not be worn down and uneven. If it is, check the wheel angles of the front wheels.

A. Normal wear.

B. Too low air pressure in tyre.

C. Too high air pressure in tyre.

- D. Imbalance in wheel.
- E. Faulty camber.
- F. Faulty toe-in.

Only tyres of the same type (diagonal, radial) and same make may be used on one and the same axle. All tyres should preferably be of the same type and make.

If the vehicle is fitted with stud tyres, all the four wheels should have stud tyres.

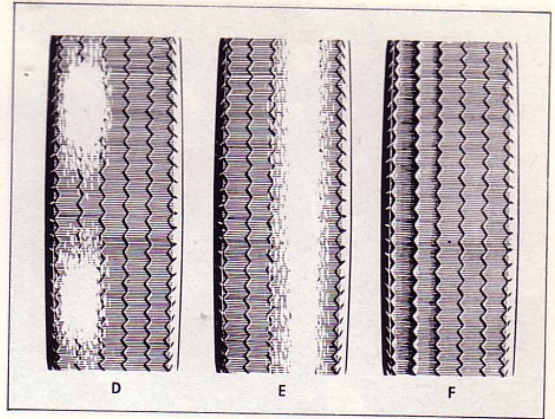

VOLVO 104770

**79.**

Change the oil filter with the help of SVO 2903. Place the plug in the engine oil sump.



VOLVO 104771

**80.**

Lubricate older vehicles in the 120-series according to the lubrication chart. (Propeller shaft, ball joints in front end.)

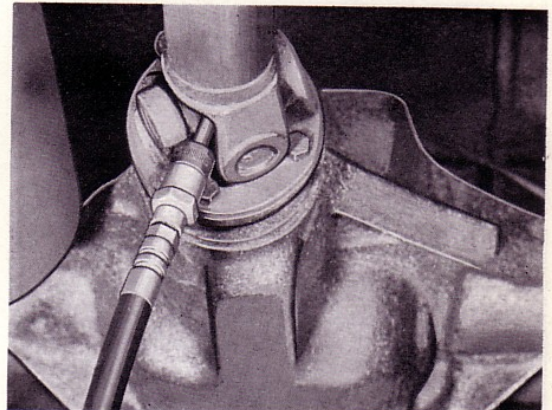

VOLVO 104812

**81. \***

Lower the lift to the bottom position. Insert the lift plates towards the middle.

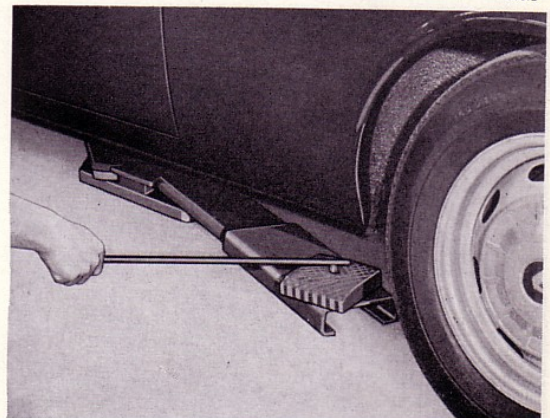

VOLVO 104753

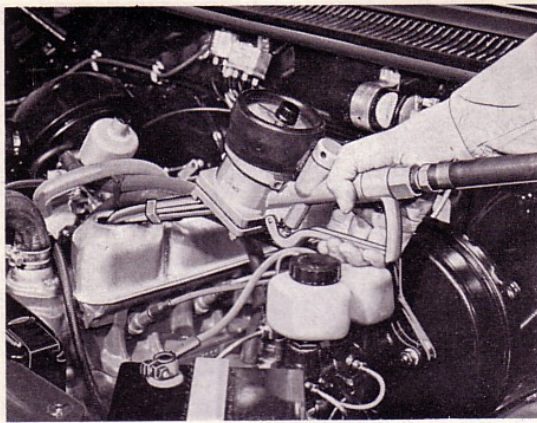
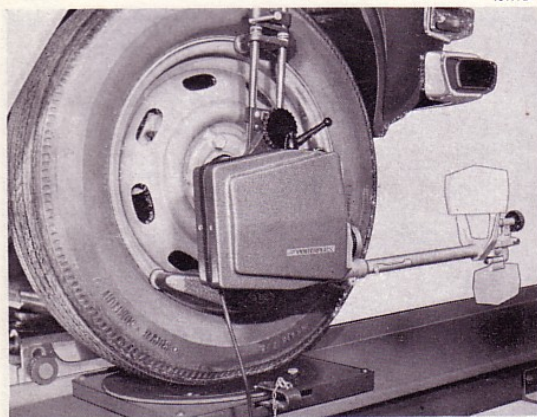
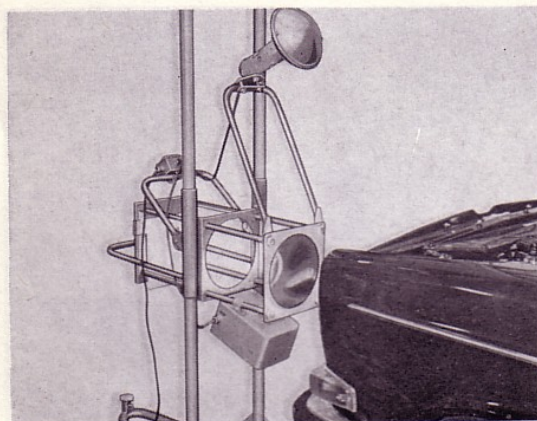
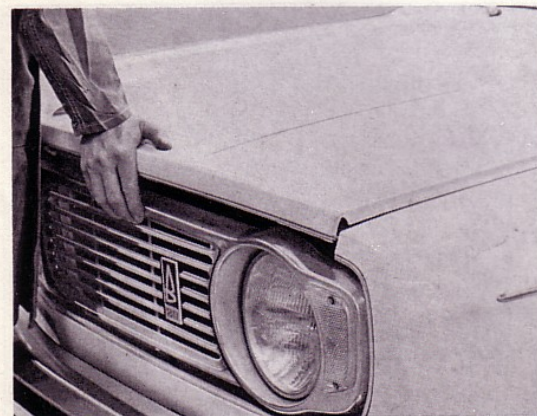
VOLVO  
104772VOLVO  
104318VOLVO  
104773VOLVO  
104774**82 A.**

Fill with engine oil:

3.75 litres (6.60 Imp. pints=7.91 US pints) for B 18 and B 20.

6.0 litres (10.56 Imp. pints=12.66 US pints) for B 30 A.

**82. B.**

Applies only when servicing is carried out without the wheel alignment indicator.

Check the front wheel toe-in.

**83. \***

Check, and if necessary adjust, the headlights.

On the 120-series, release the outer ring and adjust with the adjusting screws.

On the 140-series and 164 model adjust from inside the engine compartment. (On the 164 model the plastic cover must be removed before the adjusting screws are accessible.)

**84. \***

Remove the protection over the mudguards.

Close the bonnet (hood).

**85. \***

Wipe the steering wheel and gear lever clean.

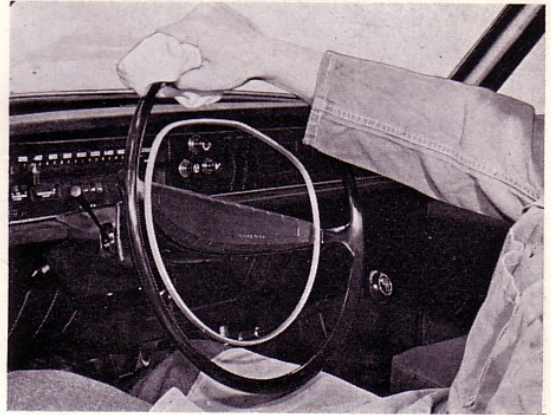
VOLVO  
104775

## 10 000 km (6000 miles) service without Volvo-Tester

**26 u. \***

Remove spark plugs, distributor cap and rotor. Clean the spark plugs and adjust the gap to 0.7—0.8 mm (0.028—0.032"). If necessary, change the spark plugs. Check the distributor breaker contacts, distributor cap, firing leads and interference suppressors.

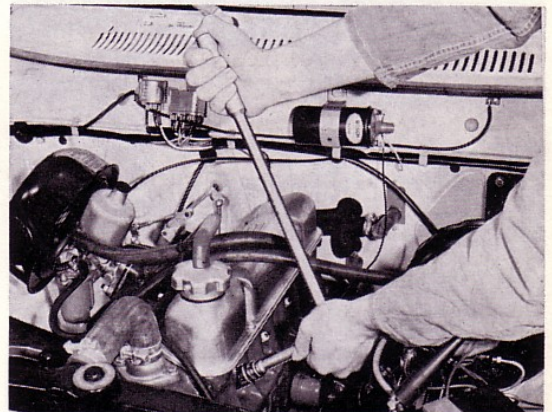
VOLVO  
104723**27 u.**

Remove the rocker arm cover and adjust the valves as follows:

Crank the engine with a fixed spanner or box spanner on the bolt for the crankshaft pulley.

Crank until No. 4 cyl. (No. 6 cyl. for 164) exhaust valve closes, and No. 4 cyl. (No. 6 cyl. for 164) intake valve opens. Set the pulley to 0°. Adjust valves Nos. 1, 2, 3, 5 (for 6 cyl. 1, 2, 3, 6, 7, 10) counted from the front.

Crank the engine until No. 1 cyl. exhaust valve closes and inlet valve opens. Set the pulley to 0°. Adjust valves Nos. 4, 6, 7, 8 (for 6 cyl. 4, 5, 8, 9, 11, 12).

See "Specifications" for the gap for the respective engine.

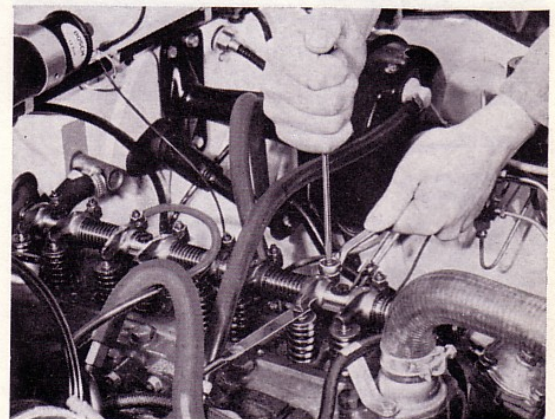
VOLVO  
104724

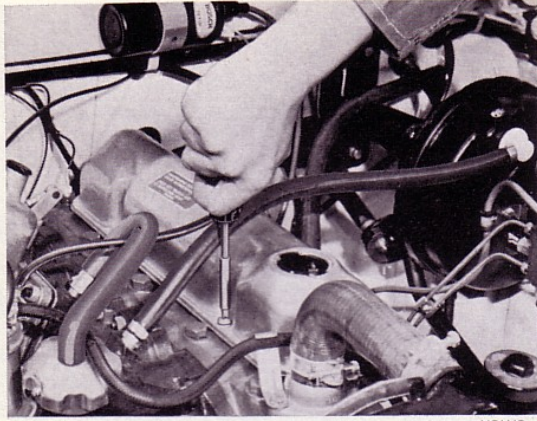
VOLVO  
104725**28 u.**

Wash the rocker arm cover and distributor cap. Fit the rocker arm cover. If necessary replace the gasket.

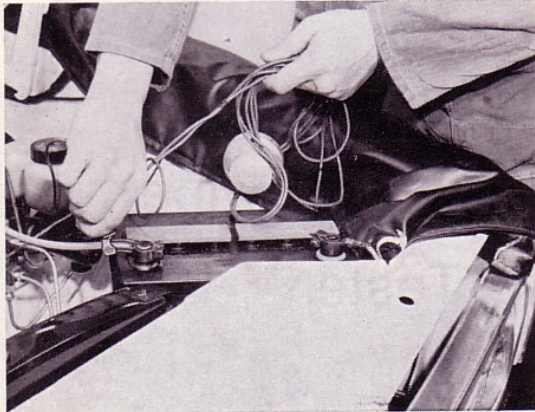
VOLVO  
104725**29 u. \***

Connect up the starter contact between terminal 50 on the starter motor and B+ on the battery. Connect up the dwell angle meter and voltmeter between B+ and B— on the battery. Connect the exhaust gas hose. Carry out a compression test.

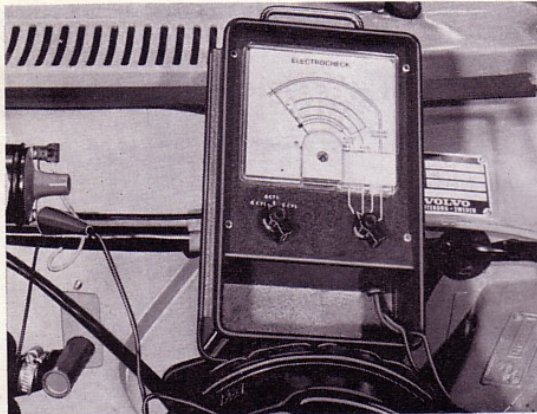
VOLVO  
104511**30 u. \***

Switch the ignition key to the driving position. Check the contact resistance of the distributor breaker contacts. Crank the engine with the starter motor and read off the dwell angle. If necessary, adjust to the proper value: B 18 and B 20, 59—65°; B 30 A, 37—43°. (No adjustment of dwell angle during Volvo test.)

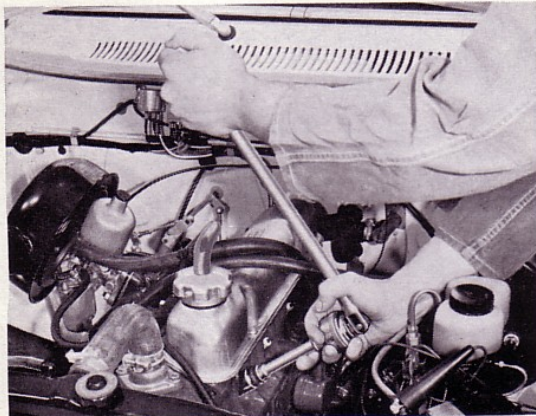
VOLVO  
104727**31 u. \***

Lubricate the distributor shaft (lubricating felt in centre of shaft). Fit the rotor and distributor cap. Fit the spark plugs. (Tightening torque: 3.5—4.0 kpm = 25—29 lb.ft.)

**32 u. \***

Remove the primary lead from terminal 1 on the ignition coil.

Read off the battery rest voltage on the voltmeter. The voltage should be minimum 12.0 volts. If it is lower than this, check the battery and charge or replace it.

Crank the engine with the starter motor and read off the start voltage of the battery. This must not be lower than 9.5 volts.

If it is lower than 9.5 volts, it may be due to a poor battery or faulty starter motor.

Reconnect the primary lead to the ignition coil.

VOLVO  
104776**33 u. \***

Connect up an ignition setting lamp.

Start the engine.

Raise the speed to about 2500 r.p.m. and read off the charging voltage. This should be 13.0—15.0 volts. Run the engine to the speed given in the "Specifications" and check and, if necessary, adjust the basic firing position.

Run the engine at 2500 r.p.m. and check the centrifugal governor function, see "Specifications".

Run the engine to the speed given in the "Specifications" and check to make sure that the vacuum governor is functioning properly.

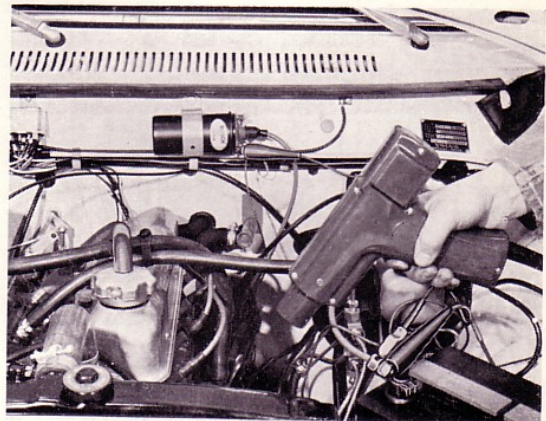
VOLVO  
104777**34 u.**

Adjust the idling speed, see "Specifications".

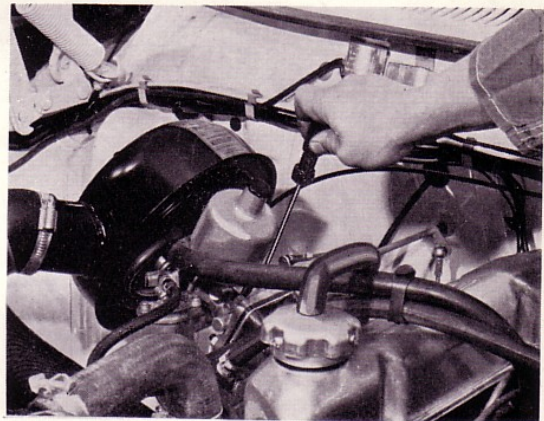
VOLVO  
104778

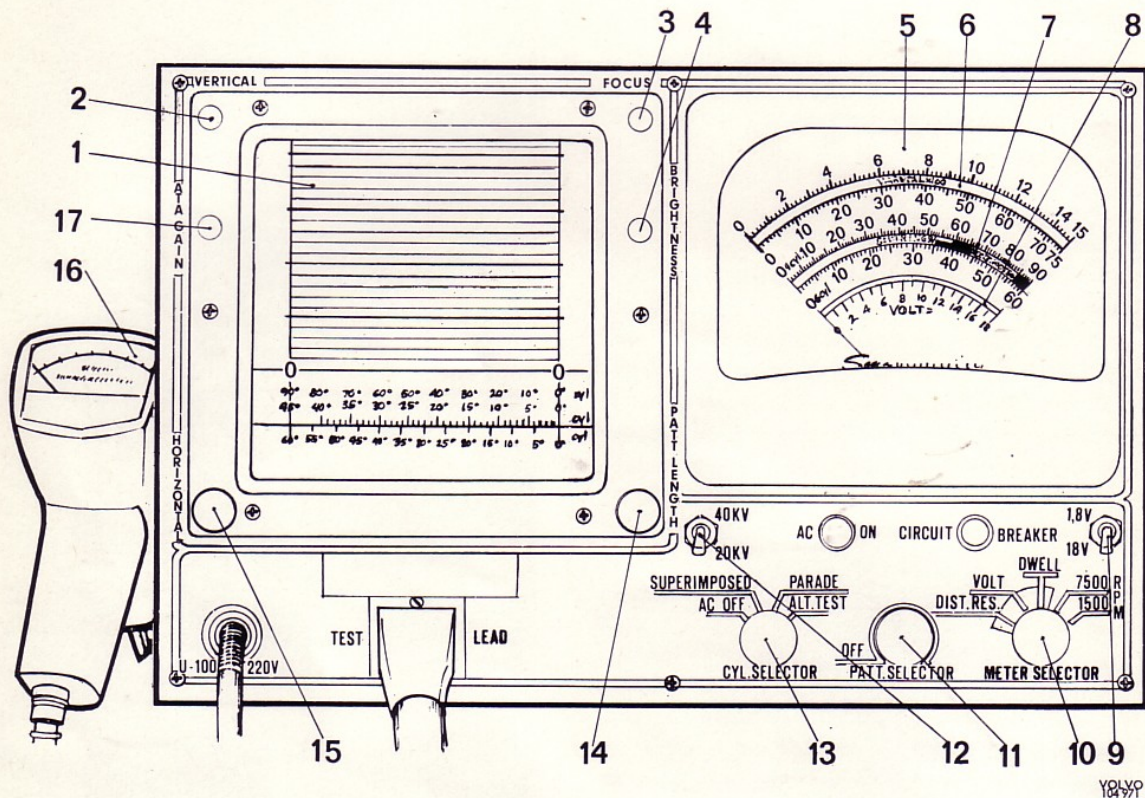

**Volvo-Tester**

- |  |   |
|--|---|
| 1. Screen                                    | 10. Meter selector                                    |
| 2. Vertical control (raises or lowers curve) | 11. Cylinder selector                                 |
| 3. Focus control                             | 12. 20-40 KV switch                                   |
| 4. Brightness control                        | 13. Pattern selector                                  |
| 5. Meter                                     | 14. Pattern length                                    |
| 6. R.p.m. scale                              | 15. Horizontal control (moves curve to left or right) |
| 7. Dwell angle scale                         | 16. Ignition setting lamp                             |
| 8. Voltage scale                             | 17. ATA gain  |
| 9. 1.8-18 V scale switch                     |   |

## REFERENCES TO WORKSHOP BULLETINS

A series of horizontal dotted lines for writing references.

RUNDQVISTS BOKTRYCKERI, GÖTEBORG 1970

