

VOLVO

300

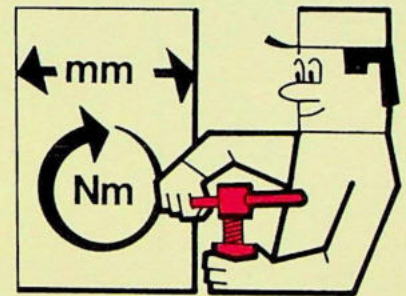

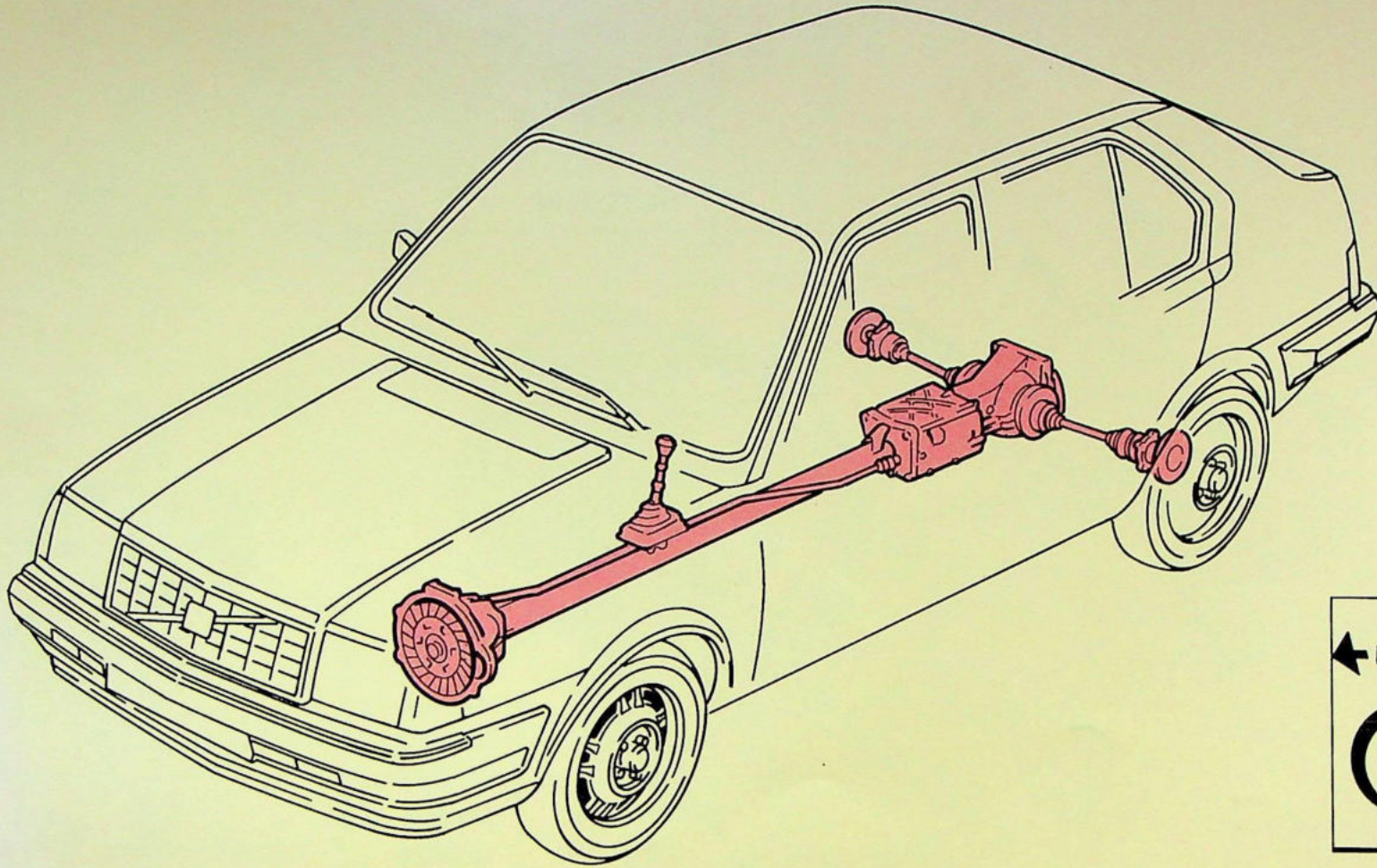
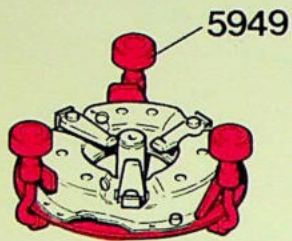

45,8 ± 0,2mm

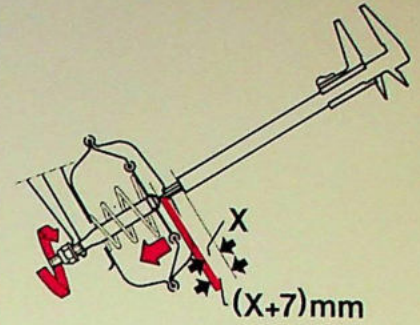
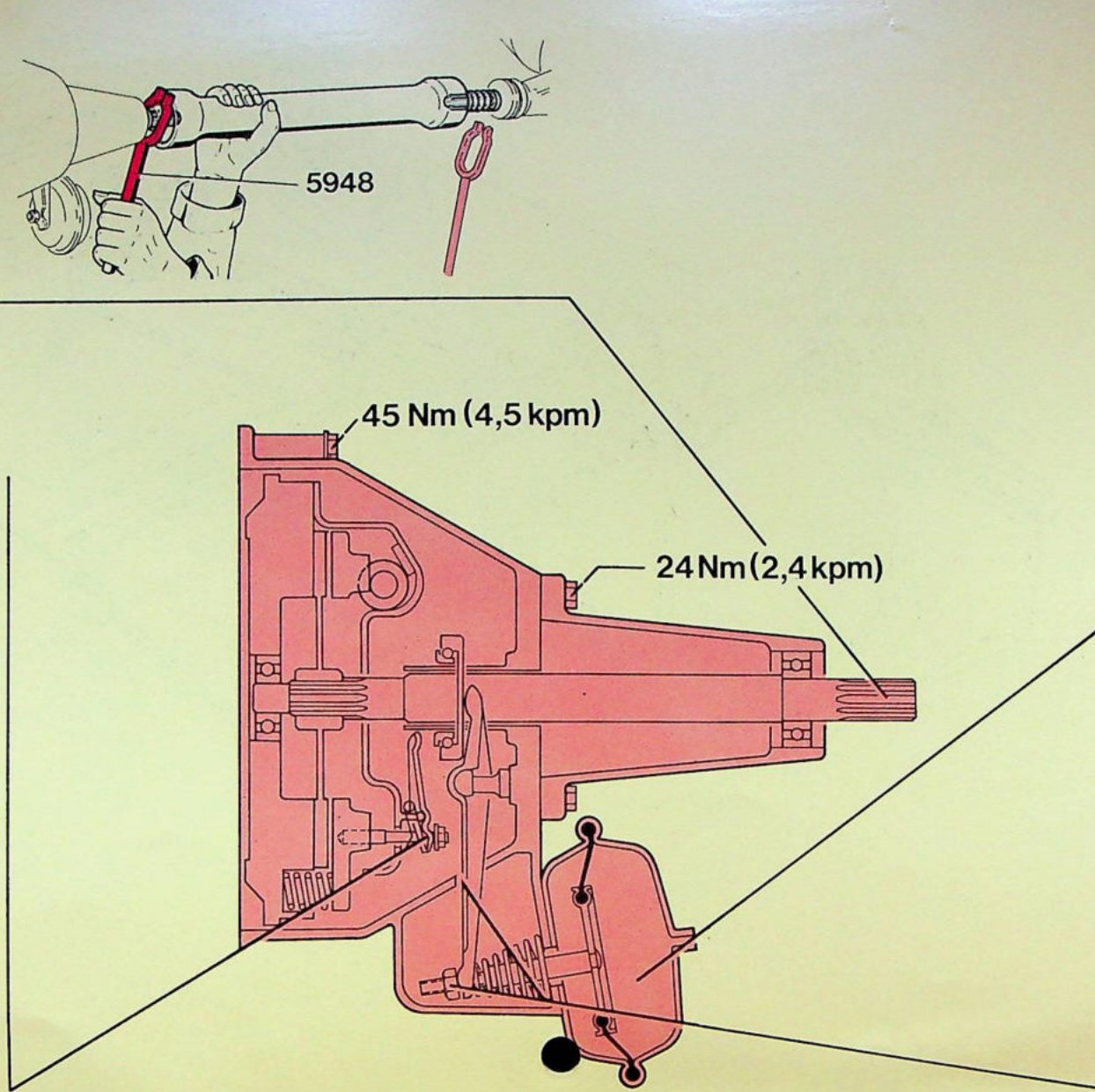
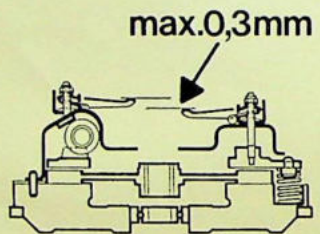

HC-314541

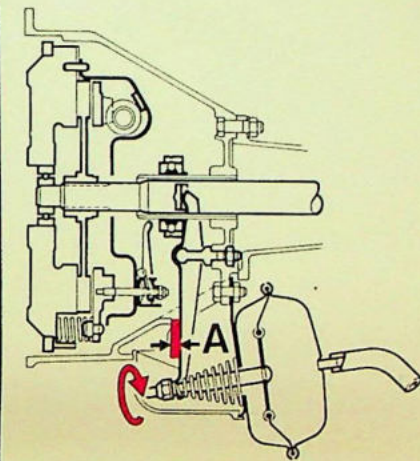
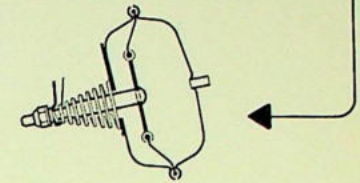

A = 1-1.5mm

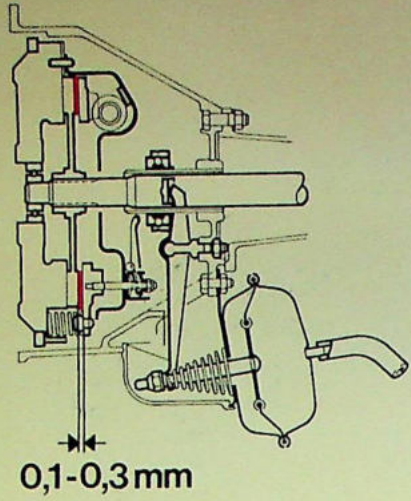

- 0,5mm
- 1,2mm
- 1,5mm
- 1,8mm
- 2,1 mm

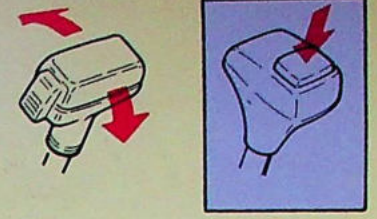
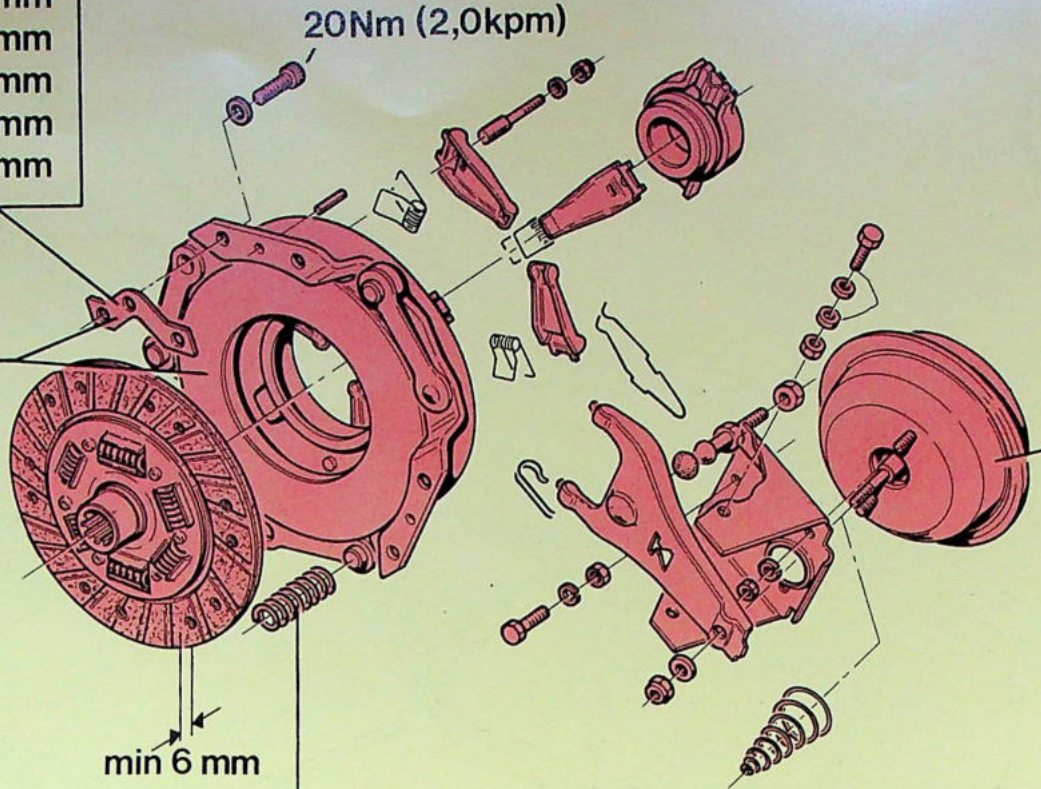

33,3 r/s
2000 r/m

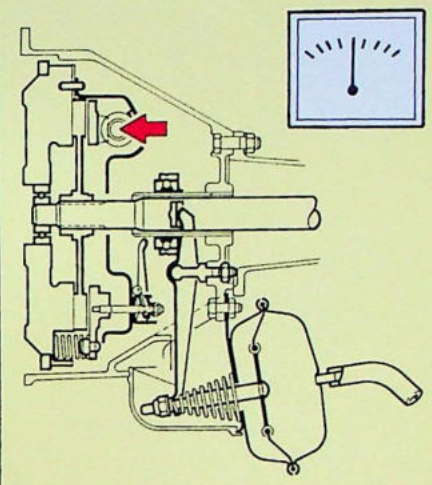
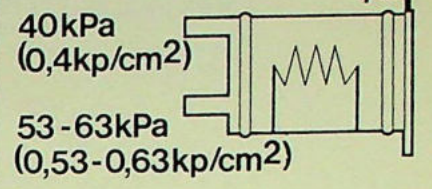

0Nm: 17,5-20 r/s
(1050-1200 r/m)

105Nm: 38,4 - 41,6 r/s
(2300-2500 r/m)

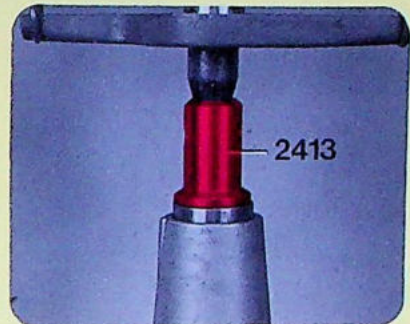
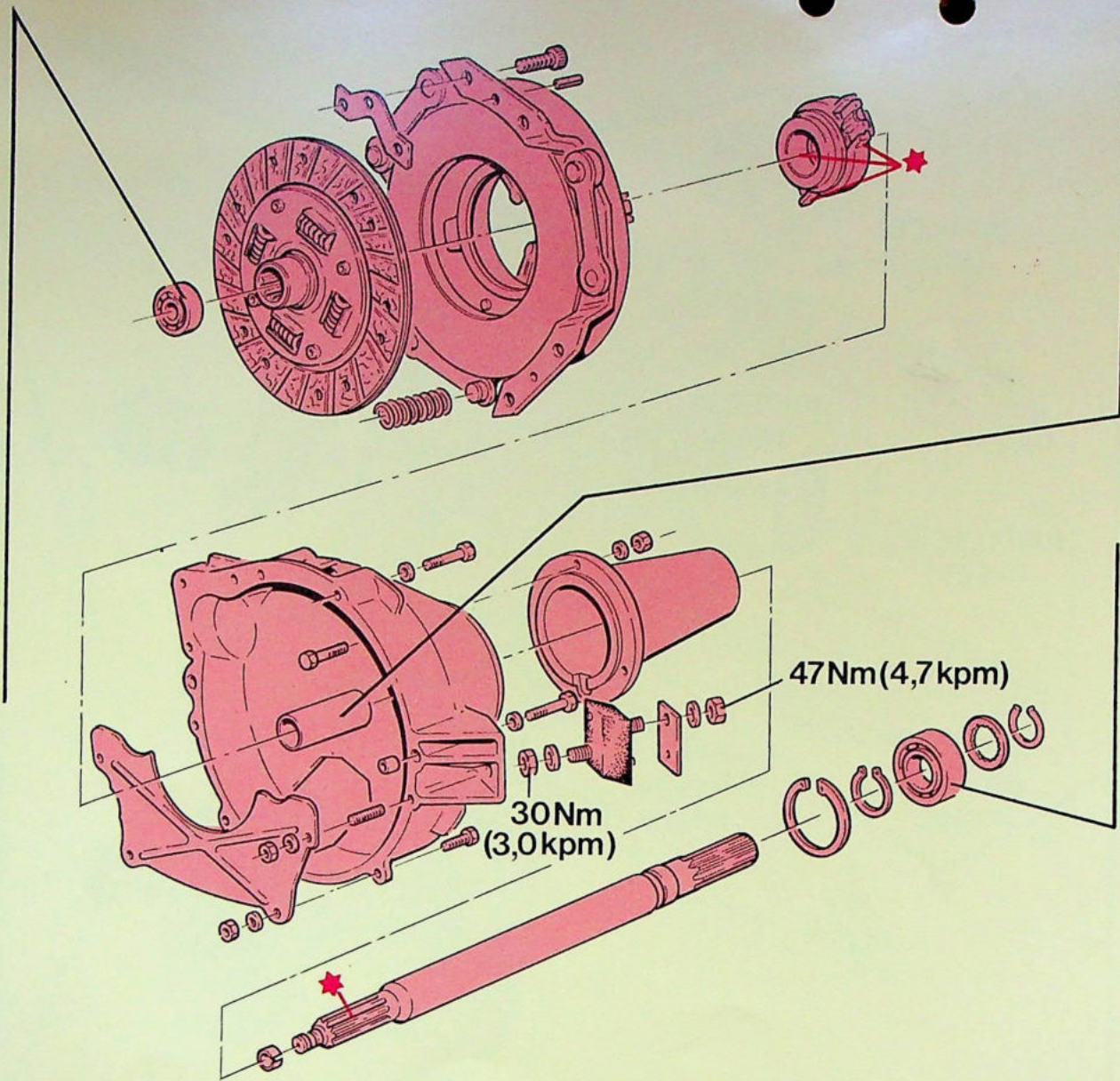
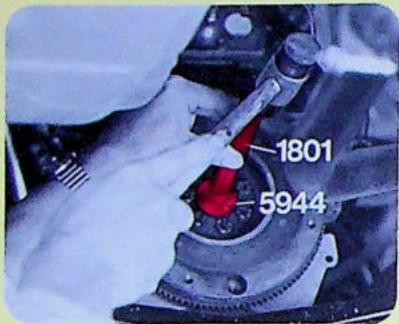
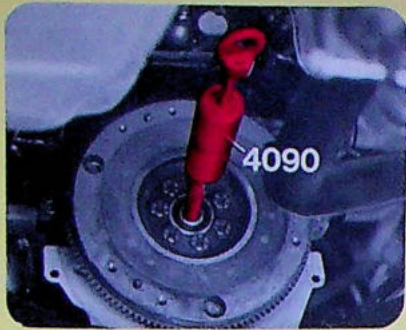

- ▲ High Tack (1161077)
- Loctite 242 (1161053)
- ★ MoS₂ (1161033)



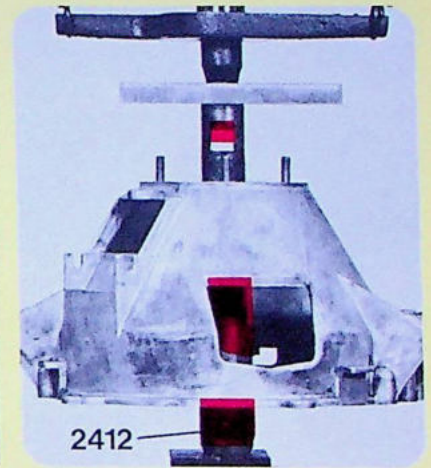
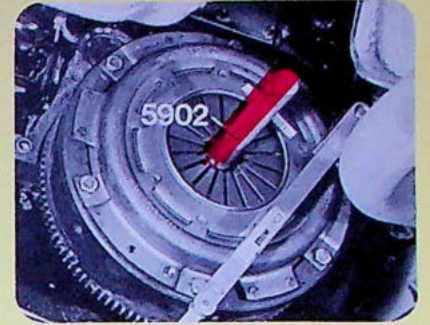
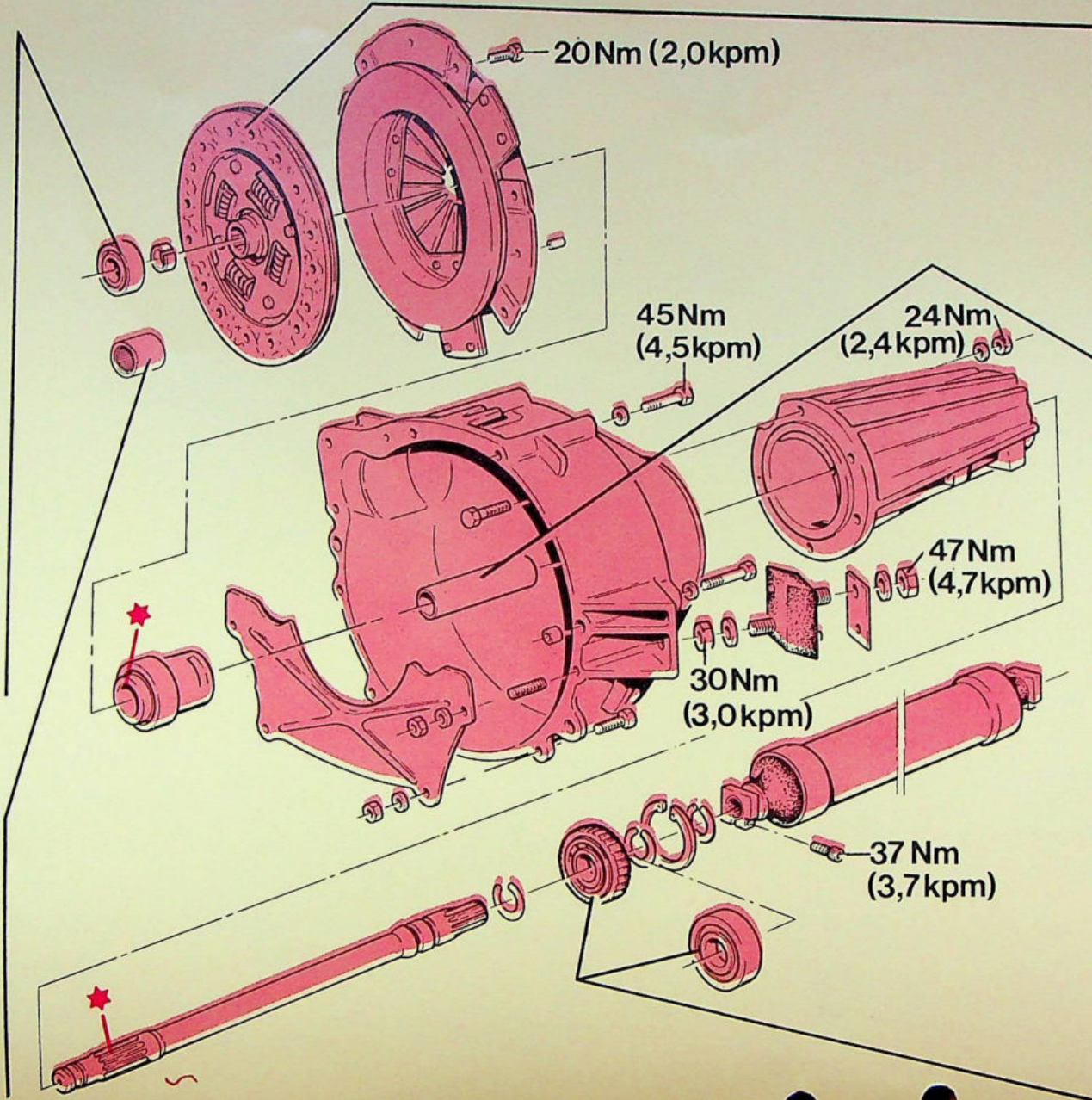
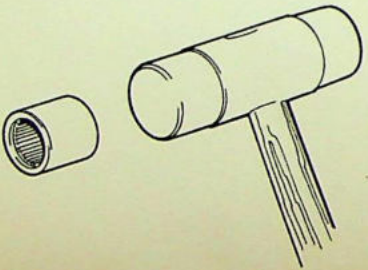
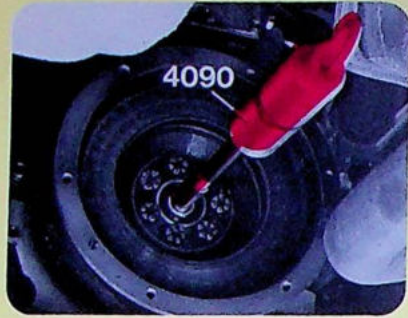

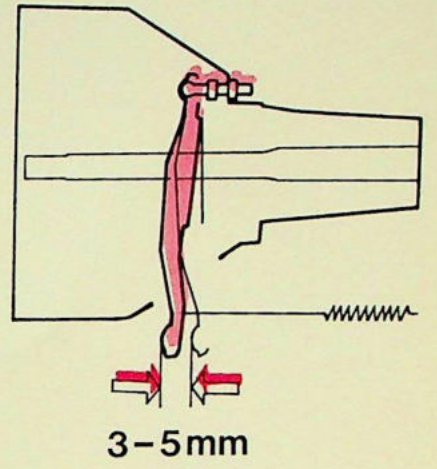
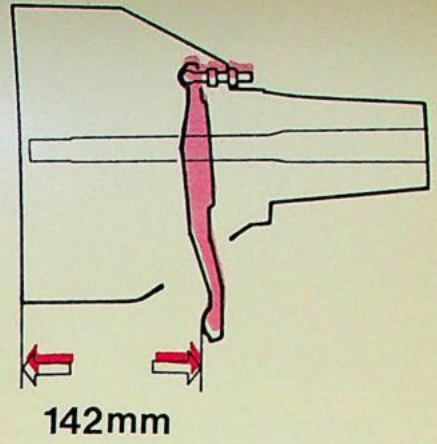
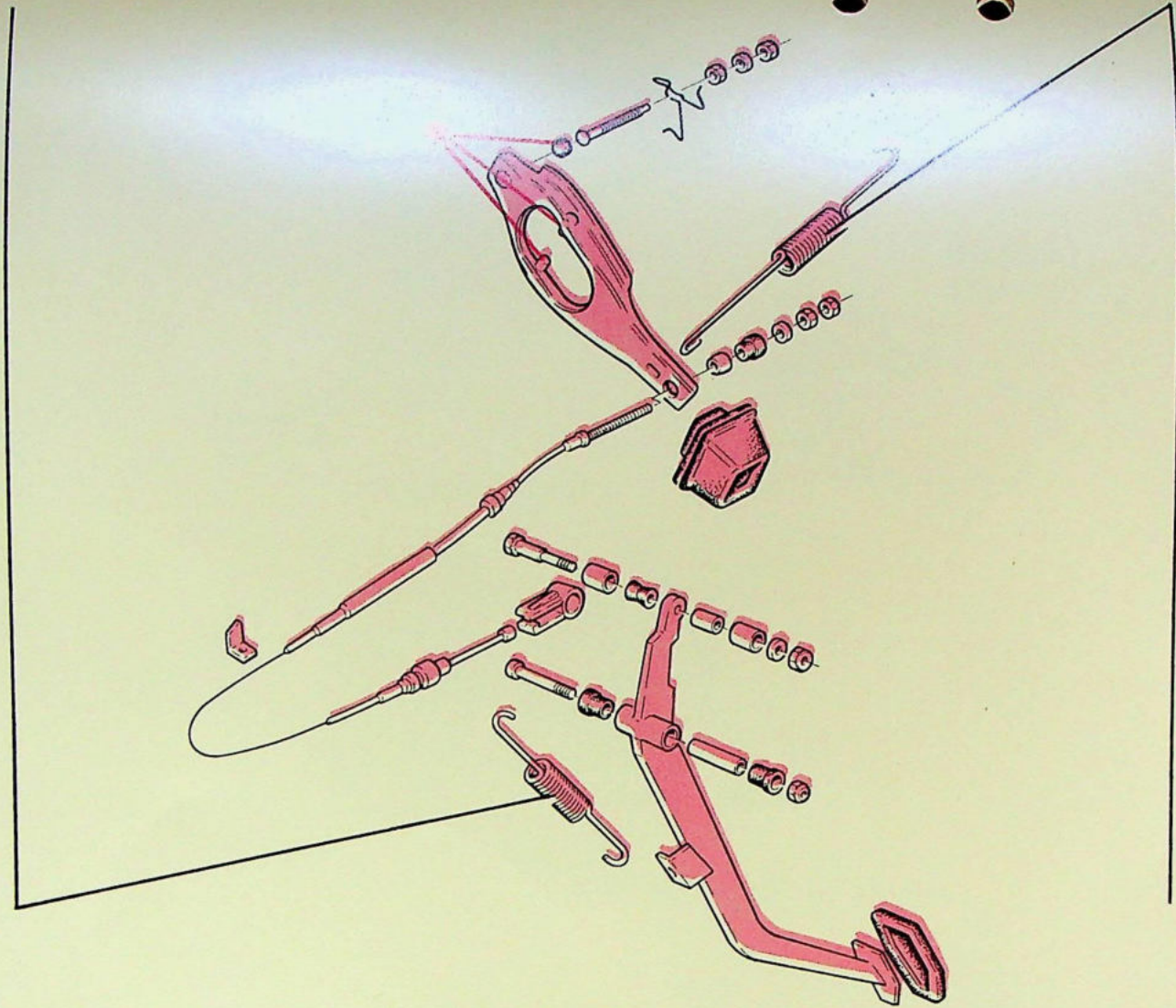
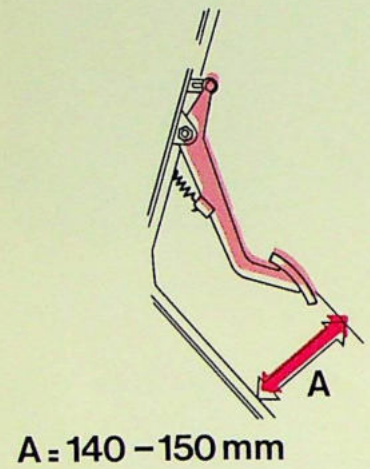
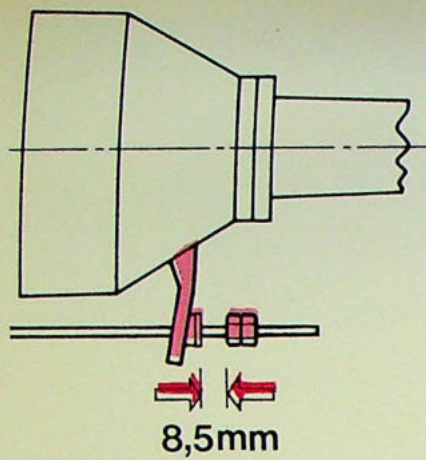

■ Loctite 242 (1161053)

★ MoS₂ (1161033)

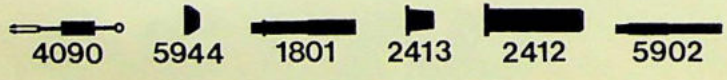

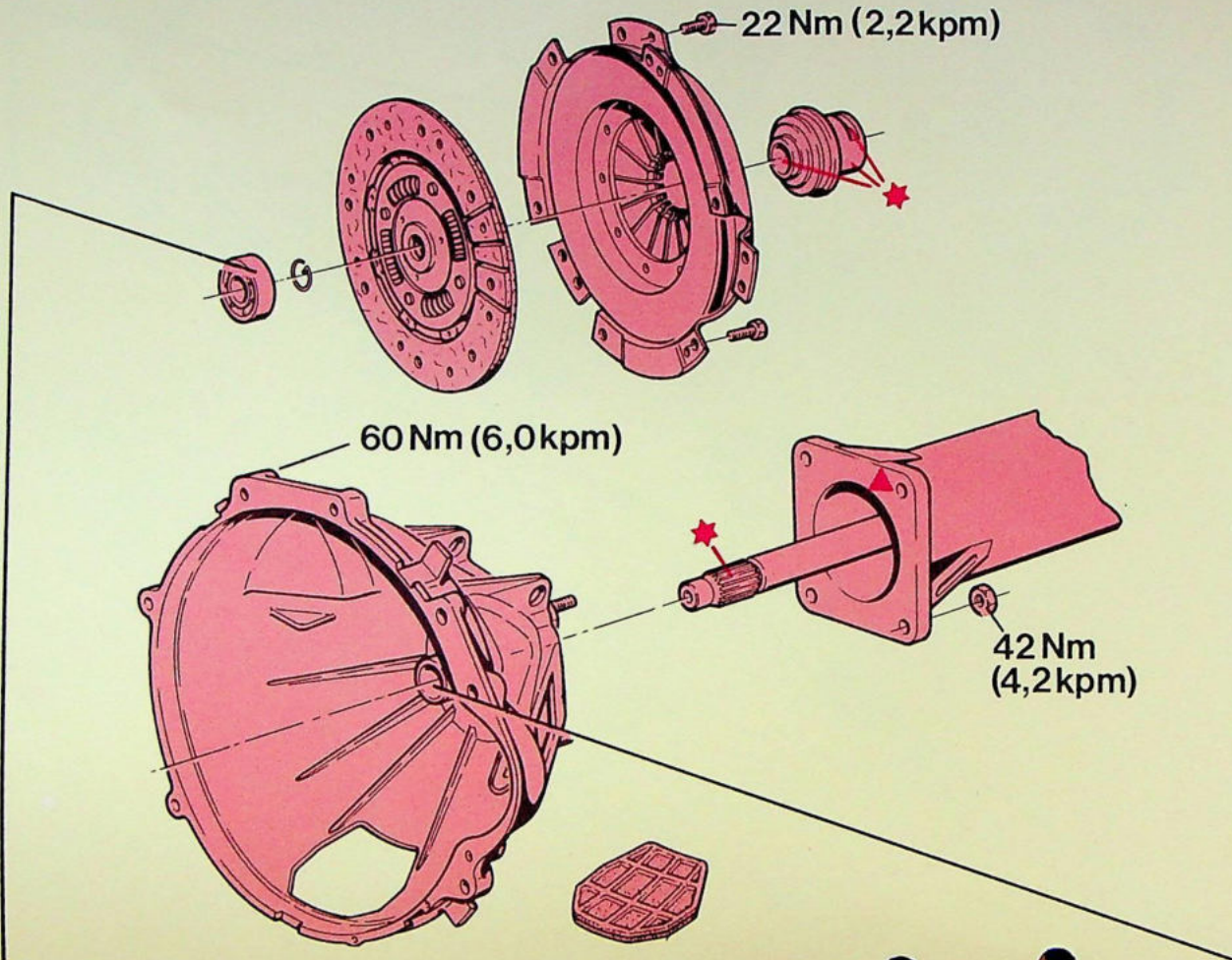
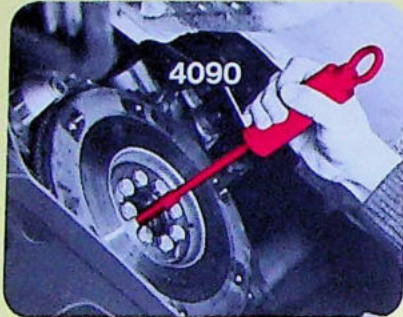
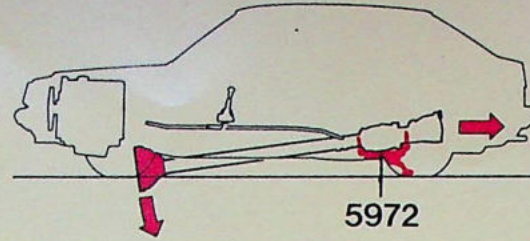

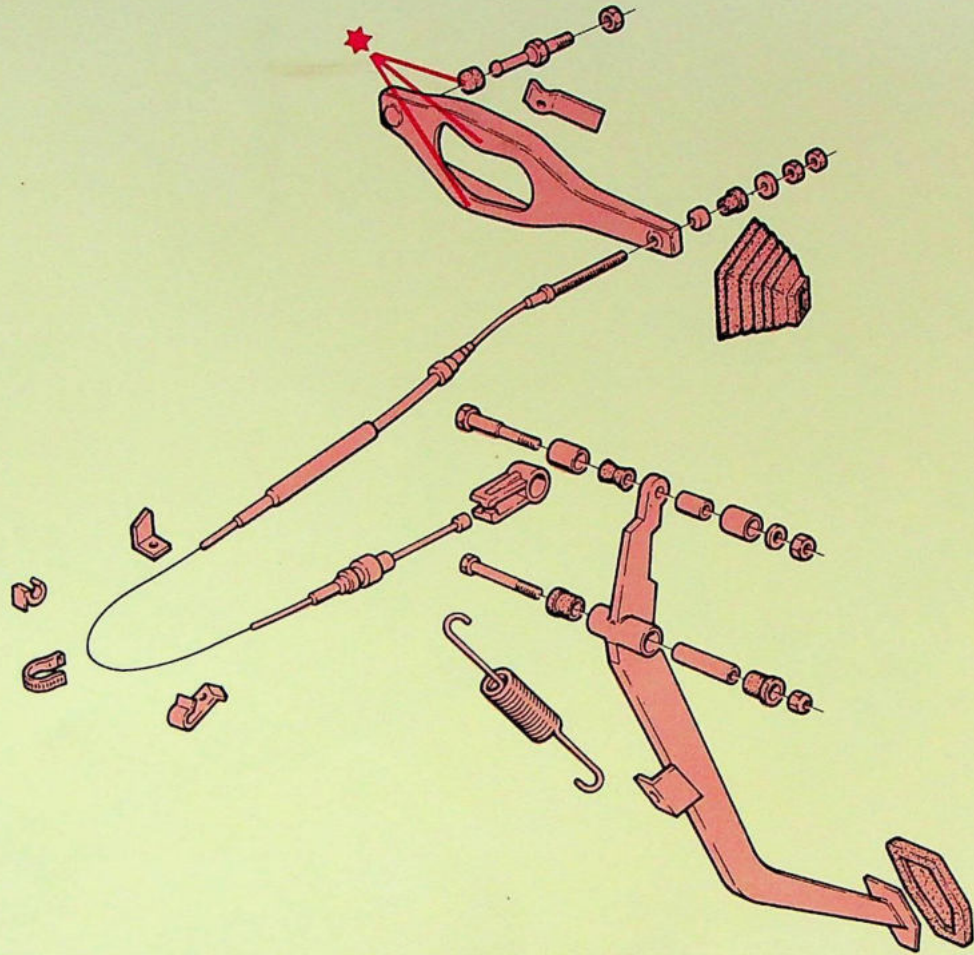

- ▲ High Tack (1161077)
- Loctite 242 (1161053)
- ★ MoS₂ (1161033)

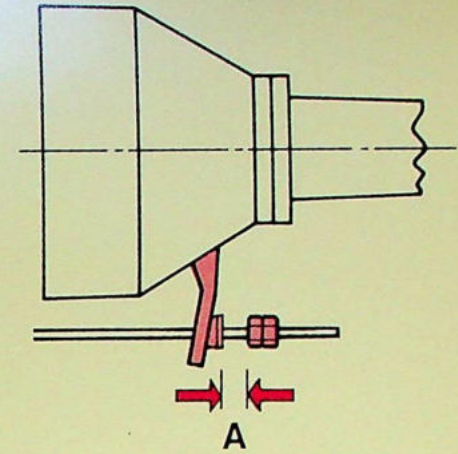
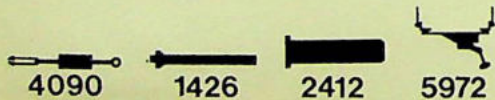

- LHD A = 7,5 mm
- RHD A = 11 mm

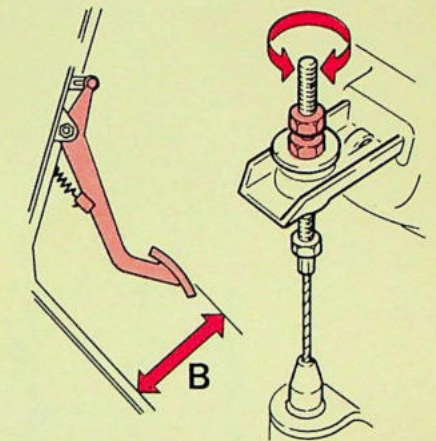

- LHD B = 150-160mm
- RHD B = 140-150mm