



VOLVO

Competition Service.

**PARTS AND EQUIPMENT
CATALOG**

\$2.00

VOLVO

Competition Service.



ORGANIZATION ORDER PROCEDURES POLICIES NOTES	1
ENGINE TUNING KITS	2A
ENGINE PARTS	2B
FUEL SYSTEMS	2C
IGNITION INSTRUMENTS LIGHTING	3
POWER TRAIN	4
SUSPENSION BRAKES	5
BODY OFF-ROAD EQUIPMENT	6
COMPETITION ACCESSORIES & CLOTHING	7
TECHNICAL ADVICE & SPECIFICATIONS	8

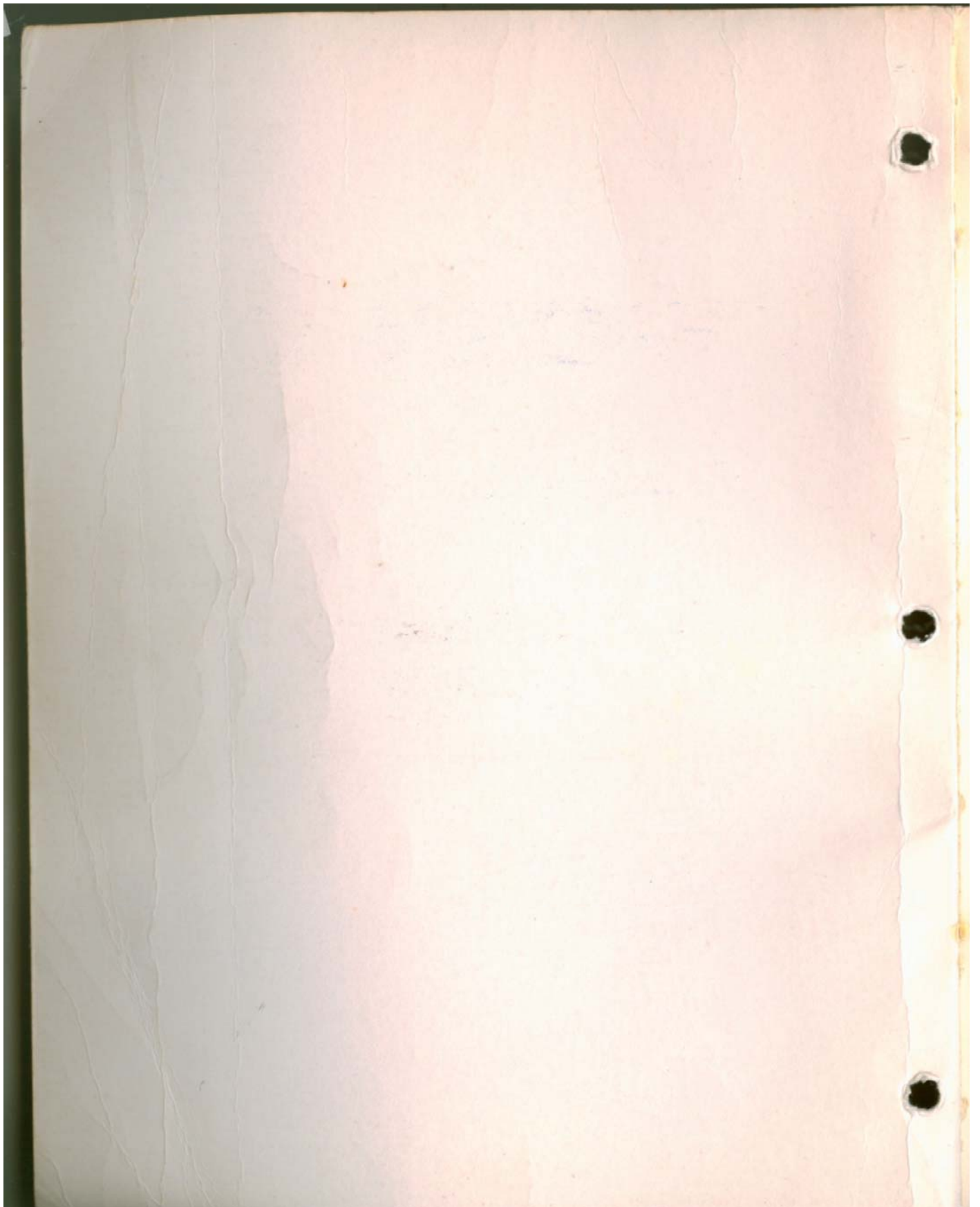



SECTION 1

Organization

Policies

Procedures

Catalog Instructions



ORGANIZATION

Sweden

Volvo Competition Service was formed in 1971 by AB Volvo in Goteborg, Sweden.

It was a new name for the "Competition Department" that actively campaigned the 544 and 122 models in European rally circles during the mid-sixties.

Today it distributes competition parts and equipment and offers advice and service to private Volvo rallyists in Europe and Volvo subsidiaries around the world.

U. S. A.

Volvo of America decided to establish a branch of Volvo Competition Service here in the U.S. during 1973. It was decided to locate the department at Volvo Western Distributing in Torrance, California, due to the high concentration of motorsport minded people and businesses in the area.

Volvo Competition Service - U.S.A. is responsible for the marketing and distribution of all genuine factory competition parts and equipment in the United States.

The entire range of products is stocked at Volvo Western Distributing and is shipped only to authorized Volvo dealers in the U.S.

Some of the equipment is designed strictly for competition off-road use and will be labeled as such. It is the owner's/ user's risk and responsibility to check for any violation of federal and state emission, safety and motor vehicle standards.

Any questions concerning parts availability, specifications, technical advice or prices may be mailed or telephoned to:

VOLVO COMPETITION SERVICE
1955-190th Street
Torrance, CA 90509

(213) 770-1550

Hours - Monday through Friday 8:30 to 5:15

All orders for parts and equipment must be placed through the Volvo dealer.

GUARANTEE

Volvo Competition Service parts and equipment are warranted for 12 months from the date of purchase and/or installation. The warranty covers the repair or replacement of any item or component found defective because of workmanship or material.

This warranty, however, does not apply to any vehicle used in competition race type events.

CATALOG INSTRUCTIONS

The new Competition Service parts catalog follows the basic format of the catalog/Microfiche as supplied by AB Volvo Parts Division.

Each one of the sections pertain to a particular subject or area of the vehicle. That is, anything electrical will be found in one section and anything dealing with the engine will be found in another.

Quarterly up-dates will be issued to each catalog holder with their respective sections for insertion indicated in a cover letter.

Notes

*Standard Part - Any part number with an asterisk appearing next to it is a standard Volvo part. Although Volvo Competition Service sometimes includes standard parts in various kits, it is impossible to order these standard parts from VCS on an individual basis.

Therefore, Volvo dealers must order all parts with an asterisk from their local area Volvo distributorship.

() - Any number appearing in parenthesis under the "Specification" column represents a measurement in either weight or size for a standard part. This is provided so that a comparison can be made between a competition part and the equivalent standard part.



SECTION 2

Engine

2

- 2A Tuning Kits
- 2B Engine Parts
- 2C Fuel System

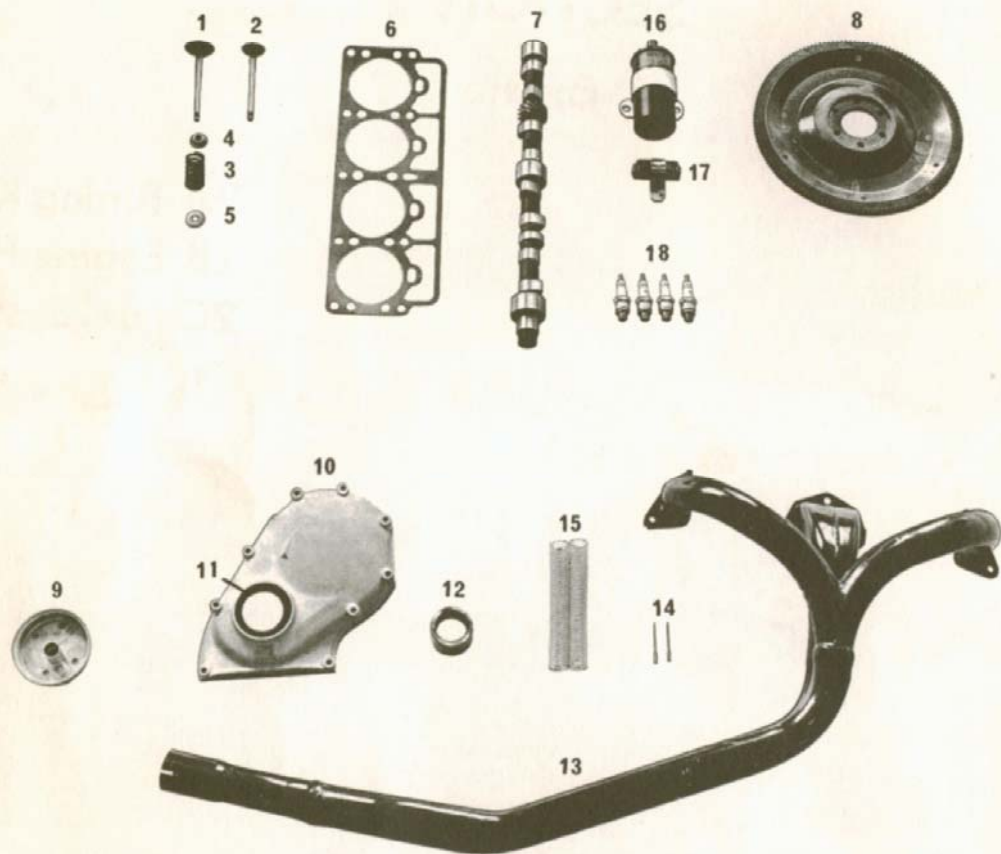

Trimmingsdetaljer för motor B18

Tuning parts for B18 engine

VOLVO

*Competition
Service*

PROD	SECTION
P130, P140, P1800	2A
Tuning Parts B18	NO. 1
DATE	
May, 1975	

Pos	Qty	Part No.	Description	Specification
1	4	419315-7	Inlet valve	Size 42mm (40) <u>Note</u> - Valve stem is smaller diameter for less flow restriction
2	4	419316-5	Exhaust valve	Size 35mm (34)
3	8	*418737-3	Valve spring	
4	8	*403500-2	Washer for valve spring	
5	8	*405357-5	Protective ring	
16		*403315-5	Valve collet	
	4	419378-5	Guide sleeve, inlet valve	Smaller i.d.
	4	*403390-8	Guide sleeve, exhaust valve	Smaller i.d.
6	1	419393-4	Cylinder head gasket - High compression	
	1	419658-0	Cylinder head gasket (for engine re-bored to 0.040" oversize)	
8	1	419392-6	Lightened Flywheel	18 lbs. (21)
9	1	419395-9	Cover oil pump for improved pick-up	
10	1	*418693-8	Timing gear cover with double neoprene seal	

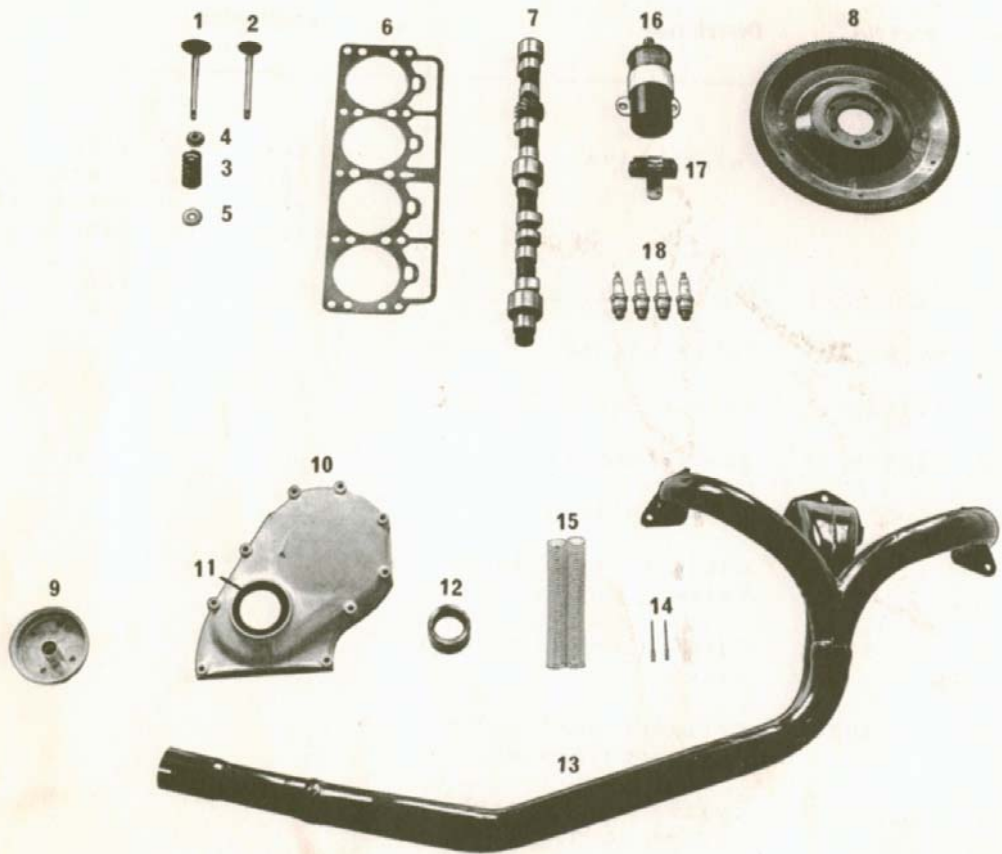

Trimningsdetaljer för motor B18
Tuning parts for B18 engine

VOLVO

Competition Service

Tuning Parts B18
Continued

SECTION

2A

NO.

2

Pos	Qty	Part No.	Description	Specification
11	1	*418668-0	Neoprene seal for above	
12	1	*418264-8	Hub for belt pulley	
13	1	419381-9	Branched exhaust manifold	2 inch end diameter 4 into 2 into 1.
16	1	*241086-8	Ignition coil (high putput)	
17	1	*241612-1	Resistor	
18	4	*240571-0	Spark plug Bosch W280T13S	
	4	*238624-1	Spark plug Bosch W240T1	

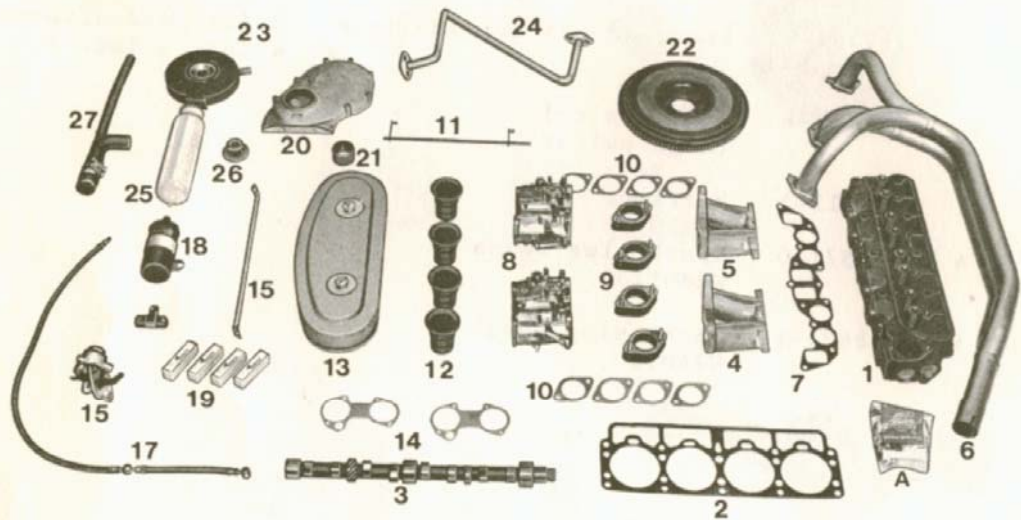

Trimningsats B20

Tuning kit B20

Det nr 552861-7

Part No 552861-7

VOLVO

PROD P130, P140, P1800	SECTION 2A
Tuning Kit B20	NO. 3
DATE May, 1975	

Pos	Qty	Part No.	Description	Specification
		552861-7	Tuning kit B20 Stage I, complete	Approx. 145 h. p. DIN
			Tuning kits are enclosed in a large wooden crate that includes many standard parts as well. All kit parts may be purchased individually.	
1	1	419882-6	Cylinder head complete	
	4	*419766-1	x Inlet valve	(std. F.I. 44mm)
	4	*419735-6	x Exhaust valve	(std. F.I. 35mm)
	8	*418737-3	x Valve spring	
	8	*419644-0	x Washer for valve spring	
	8	*419702-6	x Valve seal	
	16	*419643-2	x Valve collet	
	4	*419652-3	x Guide sleeve, inlet valve	
	4	*419653-1	x Guide sleeve, exhaust valve	
	2	*950586-8	x Cylindrical stud	
2	1	824855-1	Cylinder head gasket - High compression	Thickness 1.2mm
3	1	552460-8	Camshaft F hard-chromed	Lift .425 Duration 300°
	8	552466-5	Valve tappet hard-chromed	
4	1	419883-4	Inlet manifold, front	
5	1	419844-2	Inlet manifold, rear	
	2	422635-3	Plug for inlet manifold	

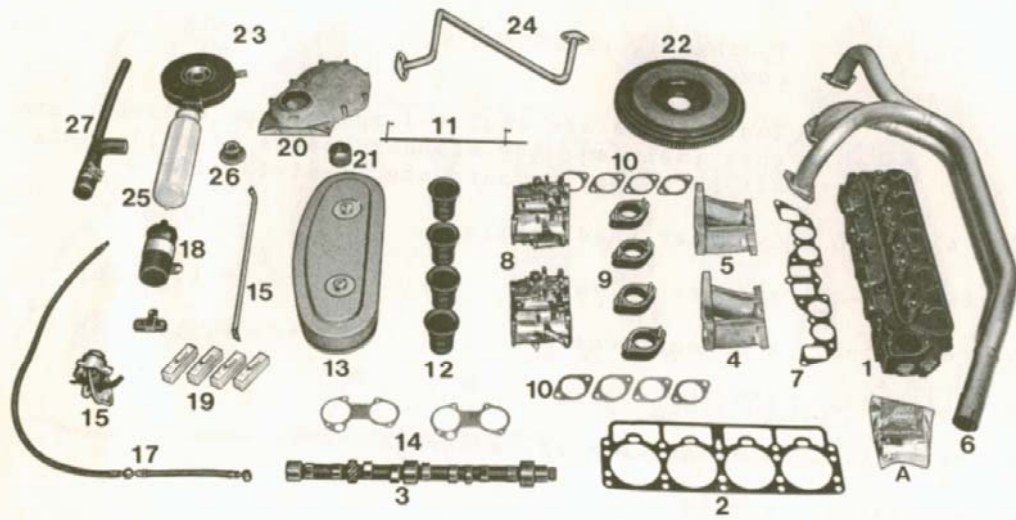

Trimningsatts B20

Det nr 552861-7

Tuning kit B20

Part No 552861-7

VOLVO

Competition Service

Stage I Kit
Continued

SECTION

2A

NO.

4

Pos	Qty	Part No.	Description	Specification
	1	*952075-0	Plug for inlet manifold	
6	1	419381-9	Branched exhaust manifold	4 into 2 into 1 2 inch collector
7	1	*419764-6	Gasket for exhaust manifold	
8	2	552600-9	Carburetor - Solex 45DDH Twin choke	
11	1	684899-8	Upper shaft, complete, for throttle control, '67 - '72	
	1	1206549-6	Upper shaft, complete for throttle control, '73 - '74	
	1	1206551-2	Bracket for throttle control	
	2	*955512-9	Screw	
	8	953461-1	Stud bolt	
	8	*955826-3	Nut	
16	*941907-8	Washer		
	8	*955847-9	Nut	
9	4	824643-1	Rubber flange for carburetor	
10	8	819769-1	Gasket for carburetor	
	1	686057-1	Intermediary shaft	
	1	*943936-5	Control rod	
12	4	824708-2	Air intake	
13	1	684036-7	Air cleaner complete	
	1	552620-7	x Air cleaner insert	
	2	552621-5	x Nut	
	2	552622-3	x Washer	
14	2	419906-3	Gasket	
	8	953032-0	Stud bolt	

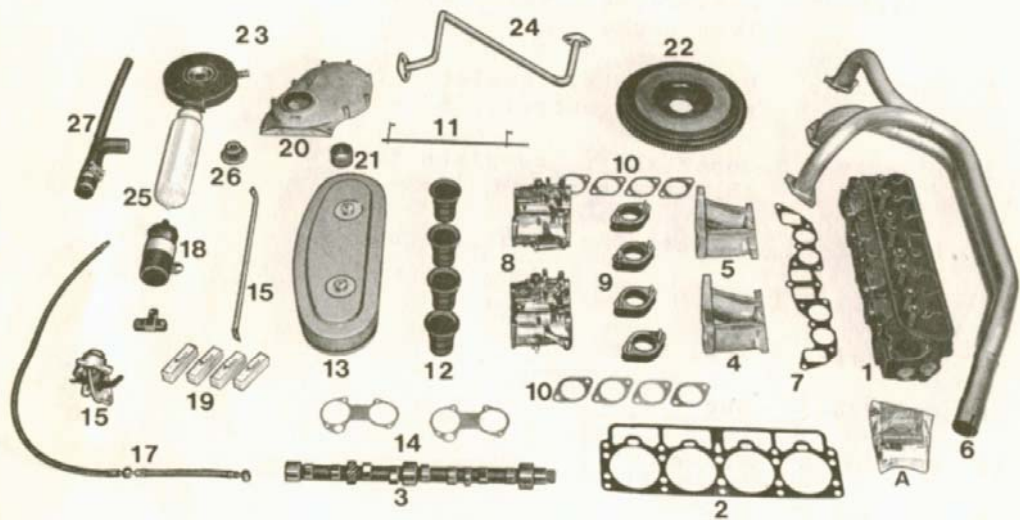

Trimningsats B20

Det nr 552861-7

Tuning kit B20

Part No 552861-7

VOLVO

Competition Service

Stage I Kit
Continued

SECTION

2A

NO.

5

Pos	Qty	Part No.	Description	Specification
	8	*946035-3	Nut	
	1	*668558-0	Lever, front	
	1	*668559-8	Lever, rear	
	1	*959088-6	Ball socket	
	1	*942837-6	Ball socket	
	1	*955780-2	Nut	
	1	*942836-8	Nut	
15	1	460047-4	Stay for air cleaner	
	1	*940097-9	Washer	
	1	*960142-8	Washer	
	1	*955536-8	Screw	
	1	*950354-1	Nut	
16	1	831092-2	Fuel pump	
	1	*946600-4	Nipple for fuel pump	
17	1	825856-8	Fuel hose	
	2	825857-6	Banjo screw for fuel hose	
	4	*957173-8	Gasket for banjo screw	
	2	825858-4	Strainer for fuel hose	
18	1	*241086-8	Ignition coil	
	1	*241612-1	Resistor	
19	4	*238624-1	Spark plug Bosch W240T1	
20	1	*418693-8	Timing gear cover with neoprene seal	
21	1	*418624-8	Hub for belt pulley	
22	1	419392-6	Flywheel complete	

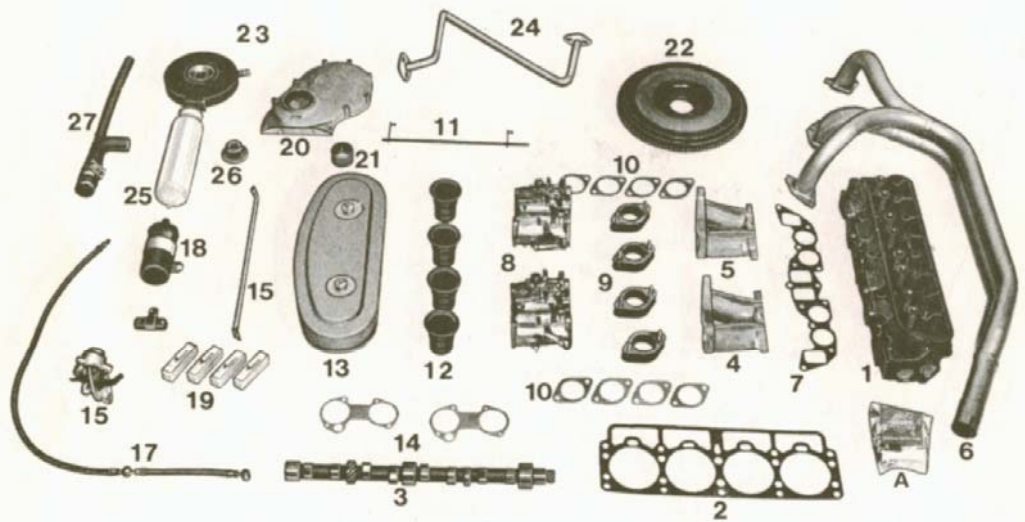

Trimningsatts B20

Det nr 552861-7

Tuning kit B20

Part No 552861-7

VOLVO

Competition Service

Stage I Kit
Continued

SECTION

2A

NO.

6

Pos	Qty	Part No.	Description	Specification
23	1	418433-9	Oil cooler - Water circulation type	
	1	*925255-2	O-ring	
	1	*191701-2	Nut	
	1	*952069-3	Plug	
24	1	*418651-6	Water pipe	
	2	*418445-3	Gasket	
	2	*940100-1	Screw	
	2	*955512-9	Screw	
	1	*418601-1	Nipple	
25	1	*676558-0	Expansion tank	
26	1	*673336-4	Pressure cap	
27	1	*671840-7	Lower radiator hose	
	1	*951789-7	Hose clip	
	1	*460464-1	Water inlet pipe	
	1	552551-4	T-union for crankcase ventilation	
	1	*943706-2	Tube 0.3 m	
	4	*942928-3	Clamp	
	1	*419446-0	T-union	
	1	*666143-3	Bushing	
	2	*959093-6	Brace	
	1	*955273-8	Bolt	
	1	*955781-0	Nut	

VALVO

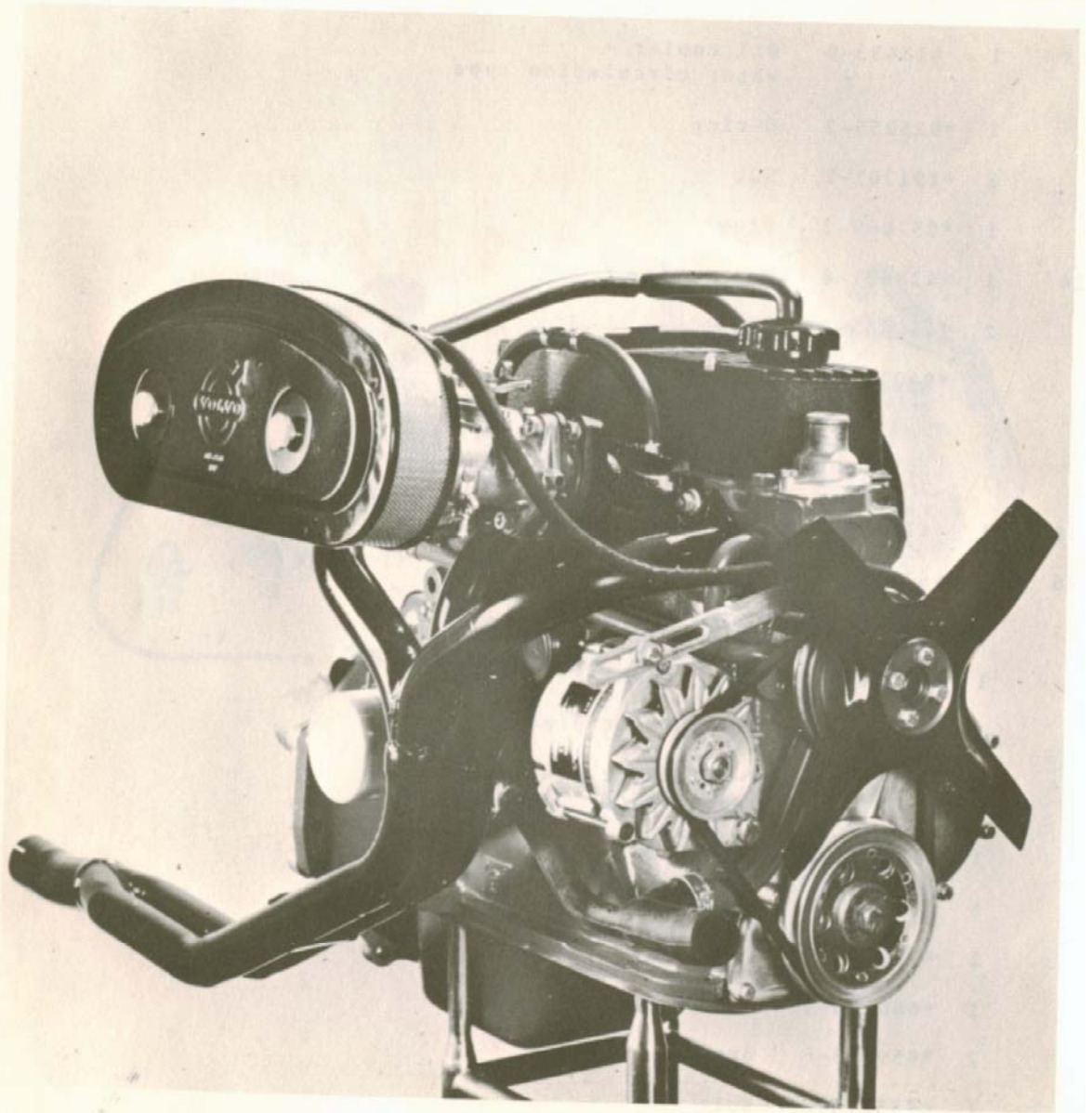

VOLVO

Competition
Service

PROD P130, P140, P1800	SECTION 2A
Tuning Kit B20 Stage II, III, IV	NO. 7
DATE May, 1975	

Pos	Qty	Part No.	Description	Specification
1	552863-3		Tuning kit B20 Stage II, complete	Approx. 165 h.p. DIN Includes all parts as Stage I (552861-7), but some components are substituted with the following more "high output" parts.
1	552842-7		Cylinder head Stage II	Ported, polished, c.c.'d 11:7:1 C.R.
4	552848-4		x Inlet valve 44mm	Stainless steel, lightened, polished
4	552849-2		x Exhaust valve 35mm	Stainless steel, lightened, polished
4	552828-6		x Guide sleeve, inlet valve, conical for less flow restriction.	
8	552841-9		Lightened valve tappet - Hard-chromed	Weight 2 oz. (3 oz.)
10	*942058-9		Hardened washer for cylinder head bolt	
4	*240571-0		Spark plug Bosch W280T13S	
<u>Stage III</u> - Approx. 175 h.p. DIN				
Not sold as a kit but referred to when customer adds individual parts as follows:				
552464-0 Stage III & IV cylinder head plus re-jetting and 38 or 40mm chokes for Solex's. (See page 12 for details).				
<u>Stage IV</u> - Approx, 185 h.p. DIN				
Same as Stage III except 93mm forged pistons are added (2200 c.c.) 552451-7. (See page 12 for details).				

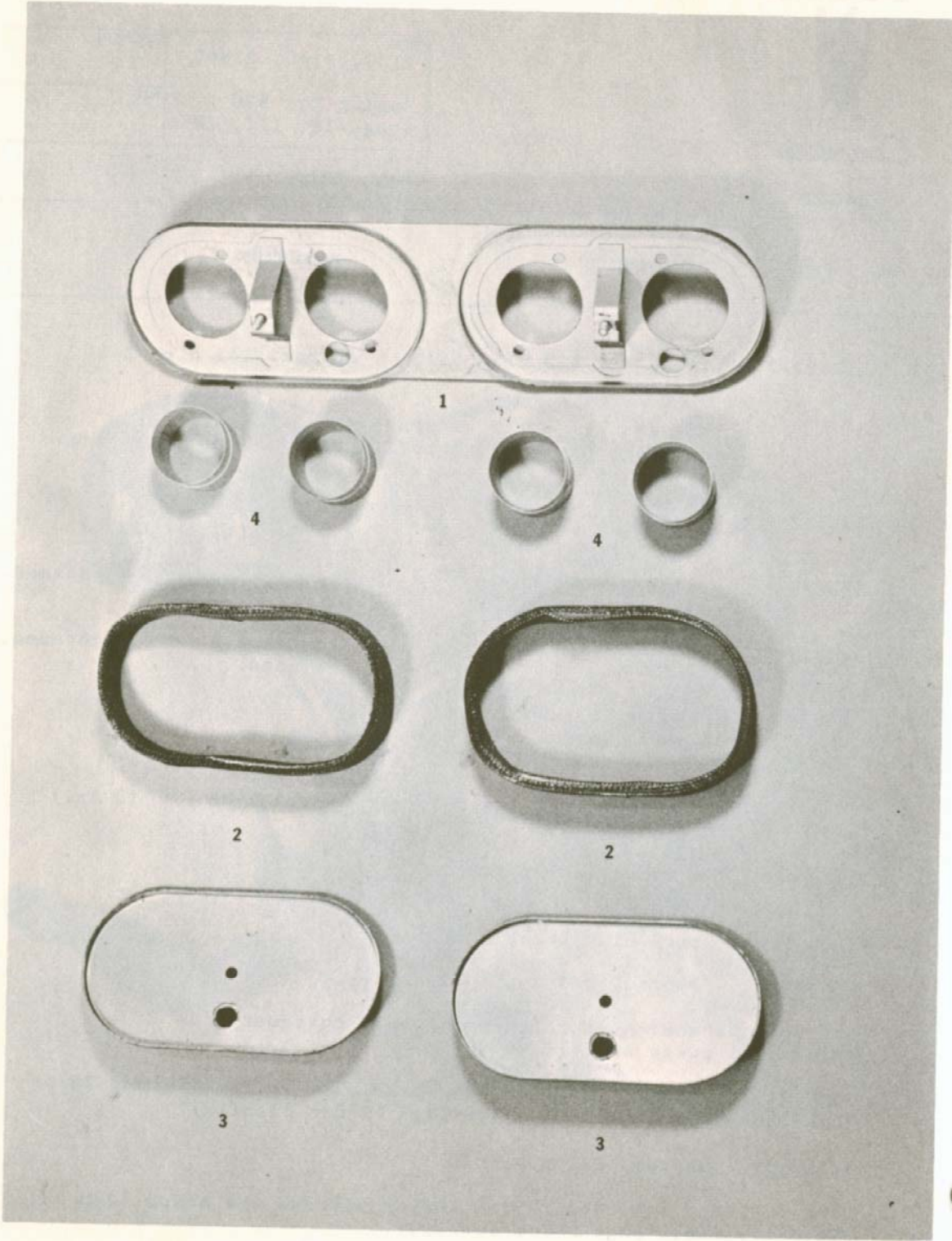

VOLVO

Competition Service

P130, 1800
Tuning Kit (Cont.)

SECTION

2A

NO.

8

Pos	Qty	Part No.	Description	Specification
-----	-----	----------	-------------	---------------

When using any of the "Stage" tuning kits in 130, 1800 or 544 models, smaller air cleaners must be fitted to provide proper inner fender clearance.

	1	*662006-6	Shaft	
	1	*191688-1	Steel washer for engine mount	
	2	*460003-7	Hose	
	1	*943706-2	Hose	
	4	*942928-3	Clamp	
	1	*942390-6	Hose	
	2	552551-4	T-union	
	1	*419446-0	T-union	
2	2	552632-2	Filter	
1	1	552631-4	Bottom plate for filter	
	1	552623-1	Rubber bushing for bottom plate	
3	2	552633-0	Top plate	
	2	*192461-2	Washer	
	2	*950352-5	Nut	
	8	*955892-5	Washer	
	1	*942461-5	Nipple	
4	4	552608-2	Air intake	

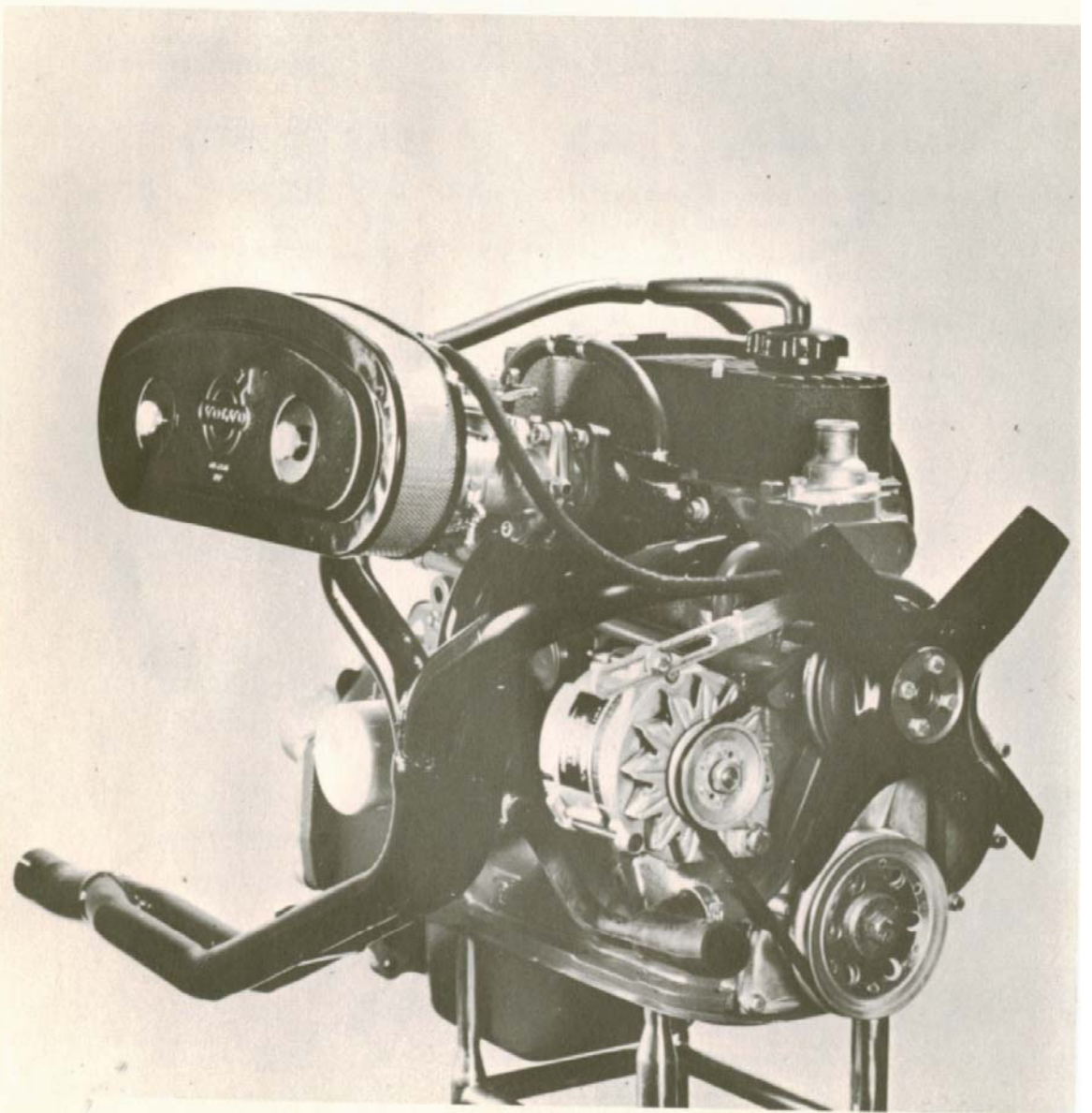

VOLVO



*Competition
Service*

PROD	SECTION
P130, P140, P1800	2A
Complete Engines	NO.
	9
DATE	
May, 1975	

Pos	Qty	Part No.	Description	Specification
-----	-----	----------	-------------	---------------

Complete engines are available to customers in four stages of tune. Each engine is balanced, blue-printed and assembled in our Competition Work Shop in Goteborg, Sweden. Engines are delivered with tuning kit fitted but without starter motor, alternator, flywheel housing, clutch, disc, fan and drive belt. Engines are only made upon order, so please allow 8 to 10 weeks for delivery.

552871-6 Stage I Engine 145 h.p. DIN

552872-4 Stage II Engine 165 h.p. DIN

Clutch 418930 and disc 418871 should be used with the above engines.

No part number Stage III Engine 175 h.p. DIN

No part number Stage IV Engine 185 h.p. DIN

Clutch 552145 and disc 552146 should be used with above engines.

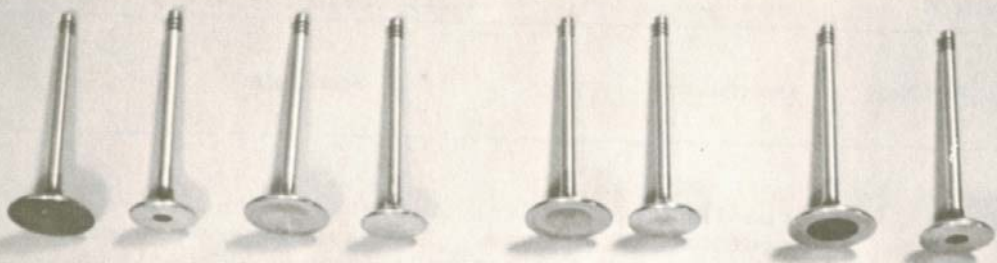

2

3

4

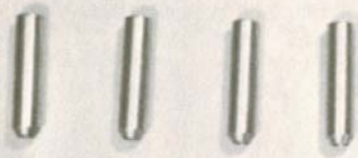

5



6

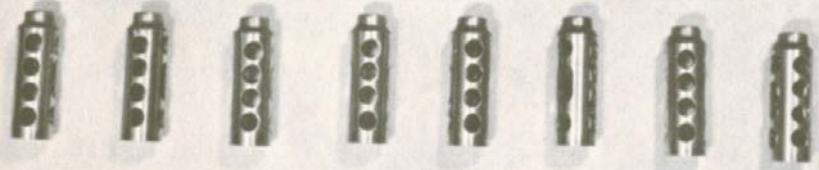

8



7

VOLVO

*Competition
Service*

PROD	SECTION
P130, P1800, P140 B20 Valves, Camshafts, Lifters	2B
DATE	NO. 10
May, 1975	

Pos	Qty	Part No.	Description	Specification
1	4	*419766-1	Stage I intake valve	44mm
1	4	*419735-1	Stage I exhaust valve	35mm
2	4	552848-4	Stage II intake valve	44mm, lightened, polished, stainless steel, stellite hardened.
2	4	552849-2	Stage II exhaust valve	35mm, same workmanship as intake
3	4	552823-7	Stage III intake valve	45mm, lightened, polished, stainless steel, stellite hardened.
3	4	552824-5	Stage III exhaust valve	38mm, same workmanship as intake.
4	4	552834-4	Intake valve	45mm, standard design and material.
4	4	552835-1	Exhaust valve	38mm, standard design and material.
5	4	552828-6	Intake valve guide	Specially tapered to reduce flow restriction.
6	1	552832-8	Shim set for B20 valve springs	Compressed length = block length of spring + 1mm clearance + max. valve lift.
	1	*419258	Camshaft D	Lift .410 Duration 280°
	1	552460-8	Hard-chrome Camshaft F	Lift .425 Duration 300°
7	1	552461-6	Hard-chrome Camshaft R	Lift .450 Duration 287°
	1	552465-7	Hard-chrome Full Race Cam	
	1	824706-6	Hard-chrome Camshaft G	Lift .457 Duration 308°

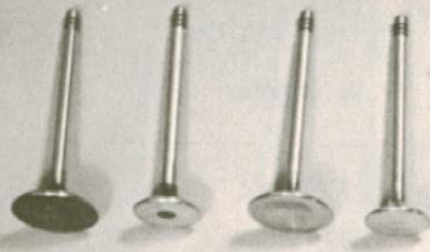

2

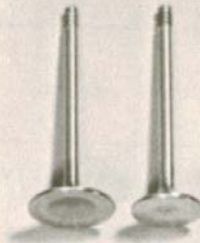

3

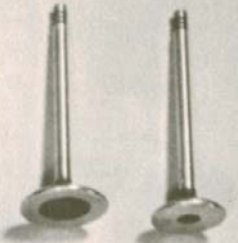

4

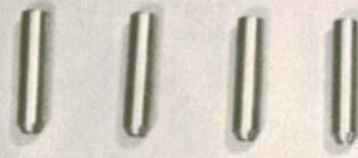

5



6

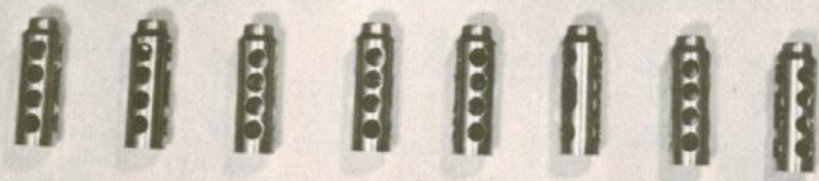

8



7

VOLVO

Competition Service

Valves, Camshafts,
Lifters (Cont.)

SECTION

2B

NO.

11

Pos	Qty	Part No.	Description	Specification
8	8	552841-9	Lightened valve lifters Special hardened	Weight 2 oz. (3 oz.)
	8	552466-5	Valve lifter - standard weight - Special hardened	